

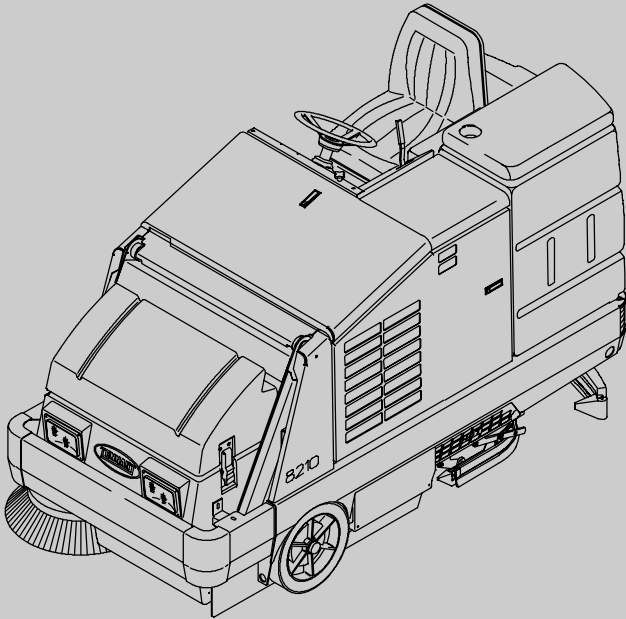

8200D

Operator Manual



This manual is furnished with each new model. It provides necessary operation and maintenance instructions.

Read this manual completely and understand the machine before operating or servicing it.

This machine will provide excellent service. However, the best results will be obtained at minimum costs if:

- The machine is operated with reasonable care.
- The machine is maintained regularly - per the machine maintenance instructions provided.
- The machine is maintained with manufacturer supplied or equivalent parts.



PROTECT THE ENVIRONMENT

Please dispose of packaging materials, old machine components such as batteries, hazardous fluids such as antifreeze and oil, in a safe environmentally way according to your local waste disposal regulations.



Always remember to recycle.

MACHINE DATA

Please fill out at time of installation for future reference.

Model No.- 8200D

Serial No.- _____

Machine Options - _____

Sales Rep. - _____

Sales Rep. phone no. - _____

Customer Number - _____

Installation Date - _____

Tennant Company

PO Box 1452

Minneapolis, MN 55440

Phone: (800) 553-8033 or (763) 523-2850



CALIFORNIA PROPOSITION 65 WARNING:

Engine exhaust from this product contains chemicals known to the State of California to cause cancer, birth defects, or other reproductive harm.

MAXPRO and ES are United States registered trademarks of the Tennant Company

Thermo Sentry is a United States trademark of Tennant Company.

Specifications and parts are subject to change without notice.

Copyright © 1998-2000, 2002-2006 TENNANT, Printed in U.S.A.

CONTENTS

	Page		Page
SAFETY PRECAUTIONS	3	OPERATOR SEAT	29
OPERATION	7	ADJUSTABLE SEAT (OPTION)	29
OPERATOR RESPONSIBILITY	7	DELUXE SUSPENSION SEAT	
MACHINE COMPONENTS	8	(OPTION)	29
SYMBOL DEFINITIONS	9	HOPPER SUPPORT BAR	31
CONTROLS AND INSTRUMENTS	11	ENGINE COVER GAS SPRING	31
OPERATION OF CONTROLS	12	LATCHES	31
DIRECTIONAL PEDAL	12	HOW THE MACHINE WORKS	32
BRAKE PEDAL	13	PRE-OPERATION CHECKLIST	33
PARKING BRAKE PEDAL	13	STARTING THE MACHINE	34
IGNITION SWITCH	14	SWEEPING, SCRUBBING, AND	
STEERING WHEEL	14	BRUSH INFORMATION	36
STEERING COLUMN TILT LEVER		SWEEPING	38
(OPTION)	14	STOP SWEEPING	39
MAIN SWEEP BRUSH DOWN		EMPTYING THE HOPPER	40
PRESSURE KNOB	15	FILLING THE TANKS	42
SIDE BRUSH LEVER	16	SCRUBBING	44
SIDE BRUSH DOWN PRESSURE		DOUBLE SCRUBBING	46
HANDLE	16	STOP SCRUBBING	46
HOPPER LEVER	16	DRAINING AND CLEANING THE TANKS	47
HOPPER DOOR LEVER	17	STOP THE MACHINE	50
CONTROL PANEL	17	POST-OPERATION CHECKLIST	51
HOURMETER	17	ENGAGING HOPPER SUPPORT BAR .	52
FUEL LEVEL GAUGE	17	DISENGAGING HOPPER SUPPORT	
SCRUB SWITCH	18	BAR	54
SQUEEGEE SWITCH	19	OPERATION ON INCLINES	55
EDGE SCRUB SWITCH (OPTION) ..	19	TIE DOWNS	55
ES SWITCH (OPTION)	20	MACHINE TROUBLESHOOTING	56
RECOVERY TANK FULL INDICATOR	20	MAINTENANCE	58
DETERGENT PUMP SWITCH		MAINTENANCE CHART	58
(OPTION)	21	LUBRICATION	60
ENGINE SPEED SWITCH	21	ENGINE	60
SWEEPING VACUUM FAN SWITCH	22	REAR WHEEL SUPPORT	60
FILTER SHAKER SWITCH	22	FRONT WHEEL BEARINGS	61
OPERATING LIGHTS SWITCH	23	HOPPER LIFT ARM PIVOTS	61
OPERATING/HAZARD LIGHT		SCRUB HEAD DRAG LINK ARMS ...	61
SWITCH (OPTION)	23	HYDRAULICS	62
SOLUTION FLOW SWITCH	23	HYDRAULIC FLUID RESERVOIR ...	62
MANUAL FLOW VALVE	24	HYDRAULIC FLUID	63
CHARGING SYSTEM LIGHT	25	HYDRAULIC HOSES	64
ENGINE OIL PRESSURE LIGHT	25	PROPELLING MOTOR	64
ENGINE WATER TEMPERATURE		ENGINE	65
LIGHT	25	COOLING SYSTEM	65
HOPPER TEMPERATURE LIGHT -		AIR FILTER INDICATOR (OPTIONAL)	65
THERMO SENTRY	26	AIR FILTER	66
OK LIGHT	26	FUEL FILTER	67
CLOGGED FILTER LIGHT (OPTION)	26	BATTERY	67
HOPPER DOOR CLOSED LIGHT		BELTS AND CHAINS	68
(OPTION)	27	ENGINE BELT	68
HYDRAULIC FILTER BYPASS LIGHT		ACCESSORY PUMP BELT	68
(OPTION)	27	STATIC DRAG CHAIN	69
HORN BUTTON	27	DEBRIS HOPPER	70
CIRCUIT BREAKERS	28	HOPPER DUST FILTER	70
FUSE	28	REMOVING HOPPER DUST FILTER	71
		THERMO SENTRY	71

CONTENTS

	Page		Page
SCRUB HEAD	72	SPECIFICATIONS	94
BRUSHES	72	GENERAL MACHINE PERFORMANCE .	94
MAIN SWEEP BRUSH	72	POWER TYPE	95
REPLACING MAIN SWEEP		STEERING	95
BRUSH	73	HYDRAULIC SYSTEM	95
CHECKING AND ADJUSTING		BRAKING SYSTEM	95
MAIN SWEEP BRUSH		TIRES	95
PATTERN	75	MACHINE DIMENSIONS	96
SIDE BRUSH	77	INDEX	97
REPLACING SIDE BRUSH	78		
SCRUB BRUSHES	79		
REPLACING THE SCRUB			
BRUSHES	80		
SOLUTION SYSTEM	80		
RECOVERY TANK	80		
SOLUTION TANK	81		
SQUEEGEES	81		
REAR SQUEEGEE	81		
LEVELING THE REAR SQUEEGEE	82		
ADJUSTING REAR SQUEEGEE			
BLADE DEFLECTION	83		
SIDE SQUEEGEES	84		
ADJUSTING THE SIDE			
SQUEEGEES	84		
SQUEEGEE BLADES	84		
REAR SQUEEGEE	84		
REPLACING OR ROTATING REAR			
SQUEEGEE BLADES	84		
SIDE SQUEEGEES	85		
REPLACING SIDE SQUEEGEE			
BLADES	85		
SKIRTS AND SEALS	86		
REAR SKIRTS	86		
BRUSH DOOR SEALS	86		
HOPPER LIP SKIRTS	86		
HOPPER SEALS	87		
HOPPER DOOR SEALS	87		
HOPPER FILTER SEALS	87		
HOPPER VACUUM FAN SEAL	88		
TANK COVER SEALS	88		
BRAKES AND TIRES	89		
SERVICE BRAKES	89		
PARKING BRAKE	89		
TIRES	89		
REAR WHEEL	89		
PUSHING, TOWING, AND			
TRANSPORTING THE MACHINE ...	90		
PUSHING OR TOWING THE			
MACHINE	90		
TRANSPORTING THE MACHINE	91		
MACHINE JACKING	93		
STORING MACHINE	93		

SAFETY PRECAUTIONS

The following precautions are used throughout this manual as indicated in their description:



WARNING: To warn of hazards or unsafe practices that could result in severe personal injury or death.

FOR SAFETY: To identify actions that must be followed for safe operation of equipment.

The machine is suited to sweep disposable debris. Do not use the machine other than described in this Operator Manual. The machine is not designed for use on public roads.

The following information signals potentially dangerous conditions to the operator or equipment:



WARNING: Engine emits toxic gases. Severe respiratory damage or asphyxiation can result. Provide adequate ventilation. Consult with your regulatory authorities for exposure limits. Keep engine properly tuned.



WARNING: Raised hopper may fall. Engage hopper support bar.



WARNING: Lift arm pinch point. Stay clear of hopper lift arms.



WARNING: Moving belt and fan. Keep away.



WARNING: Flammable materials can cause an explosion or fire. Do not use flammable materials in tank(s).



WARNING: Flammable materials or reactive metals can cause explosion or fire. Do not pick up.

FOR SAFETY:

1. **Do not operate machine:**
 - Unless trained and authorized.
 - Unless operator manual is read and understood.
 - If it is not in proper operating condition.
 - In flammable or explosive areas unless designed for use in those areas.
 - In areas with possible falling objects unless equipped with overhead guard.
2. **Before starting machine:**
 - Check for fuel, oil, and liquid leaks.
 - Keep sparks and open flame away from refueling area.
 - Make sure all safety devices are in place and operate properly.
 - Check brakes and steering for proper operation.
3. **When starting machine:**
 - Keep foot on brake and directional pedal in neutral.
4. **When using machine:**
 - Use brakes to stop machine.
 - Go slow on inclines and slippery surfaces.
 - Use care when reversing machine.
 - Move machine with care when hopper is raised.
 - Make sure adequate clearance is available before raising hopper.
 - Do not carry passengers on machine.
 - Always follow safety and traffic rules.
 - Report machine damage or faulty operation immediately.
 - Follow mixing and handling instructions on chemical containers.
5. **Before leaving or servicing machine:**
 - Stop on level surface.
 - Set parking brake.
 - Turn off machine and remove key.

SAFETY PRECAUTIONS

- 6. When servicing machine:**
 - **Avoid moving parts. Do not wear loose jackets, shirts, or sleeves.**
 - **Block machine tires before jacking machine up.**
 - **Jack machine up at designated locations only. Block machine up with jack stands.**
 - **Use hoist or jack that will support the weight of the machine.**
 - **Wear eye and ear protection when using pressurized air or water.**
 - **Disconnect battery connections before working on machine.**
 - **Avoid contact with battery acid.**
 - **Avoid contact with hot engine coolant.**
 - **Allow engine to cool.**
 - **Keep flames and sparks away from fuel system service area. Keep area well ventilated.**
 - **Use cardboard to locate leaking hydraulic fluid under pressure.**
 - **Use Tennant supplied or approved replacement parts.**

- 7. When loading/unloading machine onto/off truck or trailer:**
 - **Turn off machine.**
 - **Use truck or trailer that will support the weight of the machine.**
 - **Use winch. Do not drive the machine onto/off the truck or trailer unless the load height is 380 mm (15 in) or less from the ground.**
 - **Set parking brake after machine is loaded.**
 - **Block machine tires.**
 - **Tie machine down to truck or trailer.**

The following safety labels are mounted on the machine in the locations indicated. If these or any label becomes damaged or illegible, install a new label in its place.

EMISSIONS LABEL - LOCATED ON THE SIDE PANEL OF THE OPERATOR COMPARTMENT.



FLAMMABLE SPILLS LABEL - LOCATED ON THE SIDE PANEL OF THE OPERATOR COMPARTMENT.

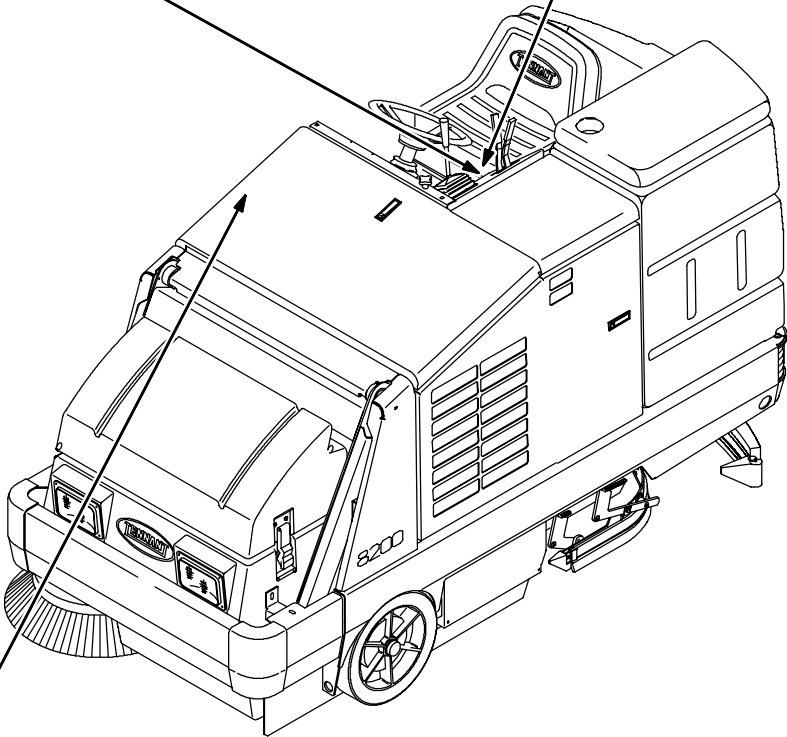

ENGINE FAN AND BELT LABEL - LOCATED ON THE RADIATOR SHROUD.

351550

SAFETY PRECAUTIONS

FLAMMABLE MATERIALS LABEL - LOCATED ON THE SOLUTION TANK COVER & ON THE BATTERY TRAY ON MACHINES WITH THE DETERGENT TANK OPTION.

FOR SAFETY LABEL - LOCATED ON THE SIDE PANEL OF THE OPERATOR COMPARTMENT.

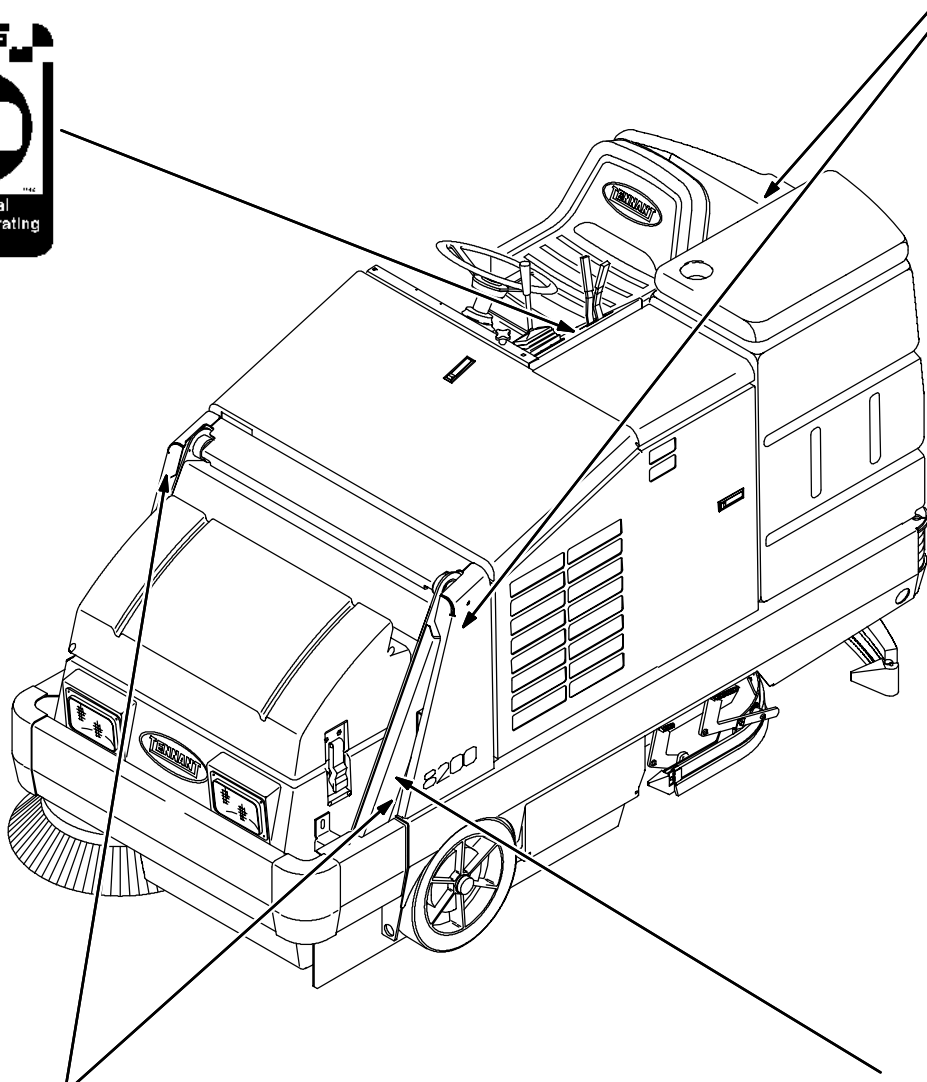

HOPPER SUPPORT BAR LABEL - LOCATED ON THE HOPPER SUPPORT BAR AND ON BOTH HOPPER LIFT ARMS.



HOPPER LIFT ARMS LABEL - LOCATED ON BOTH HOPPER LIFT ARMS.

351550

OPERATION

OPERATOR RESPONSIBILITY

- The operator's responsibility is to take care of the daily maintenance and checkups of the machine to keep it in good working condition. The operator must inform the service mechanic or supervisor when the required maintenance intervals occur as stated in the *MAINTENANCE* section of this manual.
- Read this manual carefully before operating this machine.

FOR SAFETY: Do not operate machine, unless operation manual is read and understood.

- Check the machine for shipping damage. Check to make sure machine is complete per shipping instructions.
- Keep your machine regularly maintained by following the maintenance information in this manual. We recommend taking advantage of a regularly scheduled service contract from your Tennant representative.
- Order parts and supplies directly from your authorized Tennant representative. Use the parts manual provided when ordering parts.
- After the first 50 hours of operation, follow the recommended procedures stated in the *MAINTENANCE CHART*.

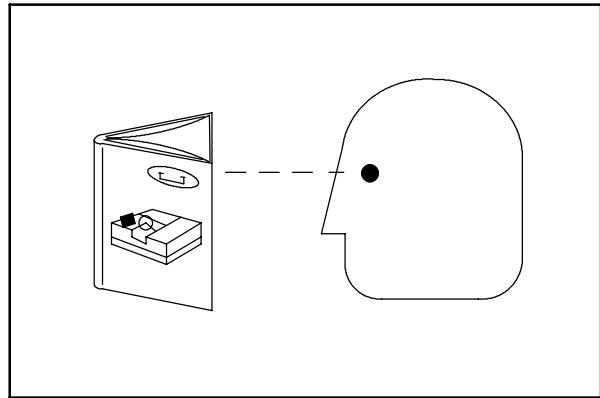

07324

OPERATION

MACHINE COMPONENTS

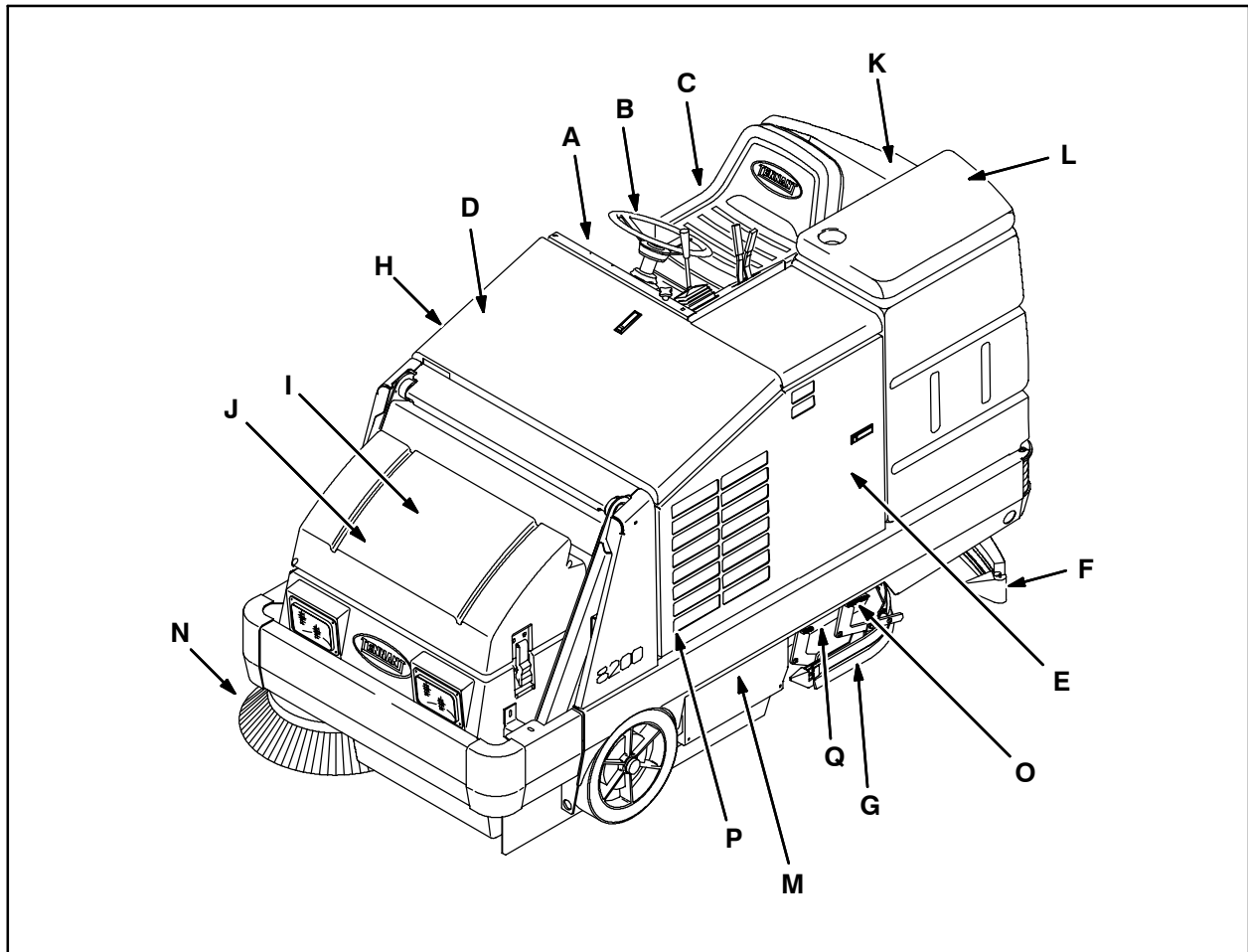

351550

- A. Control panel
- B. Steering wheel
- C. Operator seat
- D. Engine cover
- E. Engine side door
- F. Rear squeegee
- G. Side squeegee
- H. Sweeping brush access door
- I. Hopper cover
- J. Hopper dust filter
- K. Solution tank
- L. Recovery tank
- M. Main sweeping brush
- N. Side brush
- O. Scrub brushes
- P. Detergent tank (option)
- Q. Scrub head

SYMBOL DEFINITIONS

These symbols identify controls, displays, and features on the machine:



Hazard light



Operating lights



Hopper door open



Hopper door close



Hopper raise



Hopper lower



Filter shaker



Side brush down and on



Side brush up and off



Main brush down and on



Main brush up and off



Charging system



Engine oil pressure



Engine water temperature



Recovery tank full



Filter clogged



Hopper temperature - Thermo Sentry



Diagnostics



Diesel fuel only



Hourmeter



Fan



ES (option)



Detergent flow



Scrub brush edge clean



Scrub brushes down and on



Rear squeegee down and vacuum on



Engine



Variable pressure

OPERATION



Solution flow



Side brush down pressure light



Side brush down pressure heavy



Main sweep brush down pressure light



Main sweep brush down pressure heavy



Horn



Hydraulic fluid only



Jackpoint



Glow plugs (preheat)



Circuit breaker 1



Circuit breaker 2



Circuit breaker 3



Circuit breaker 4



Circuit breaker 5



Circuit breaker 6



Circuit breaker 7



Circuit breaker 8



Steering tilt (option)

CONTROLS AND INSTRUMENTS

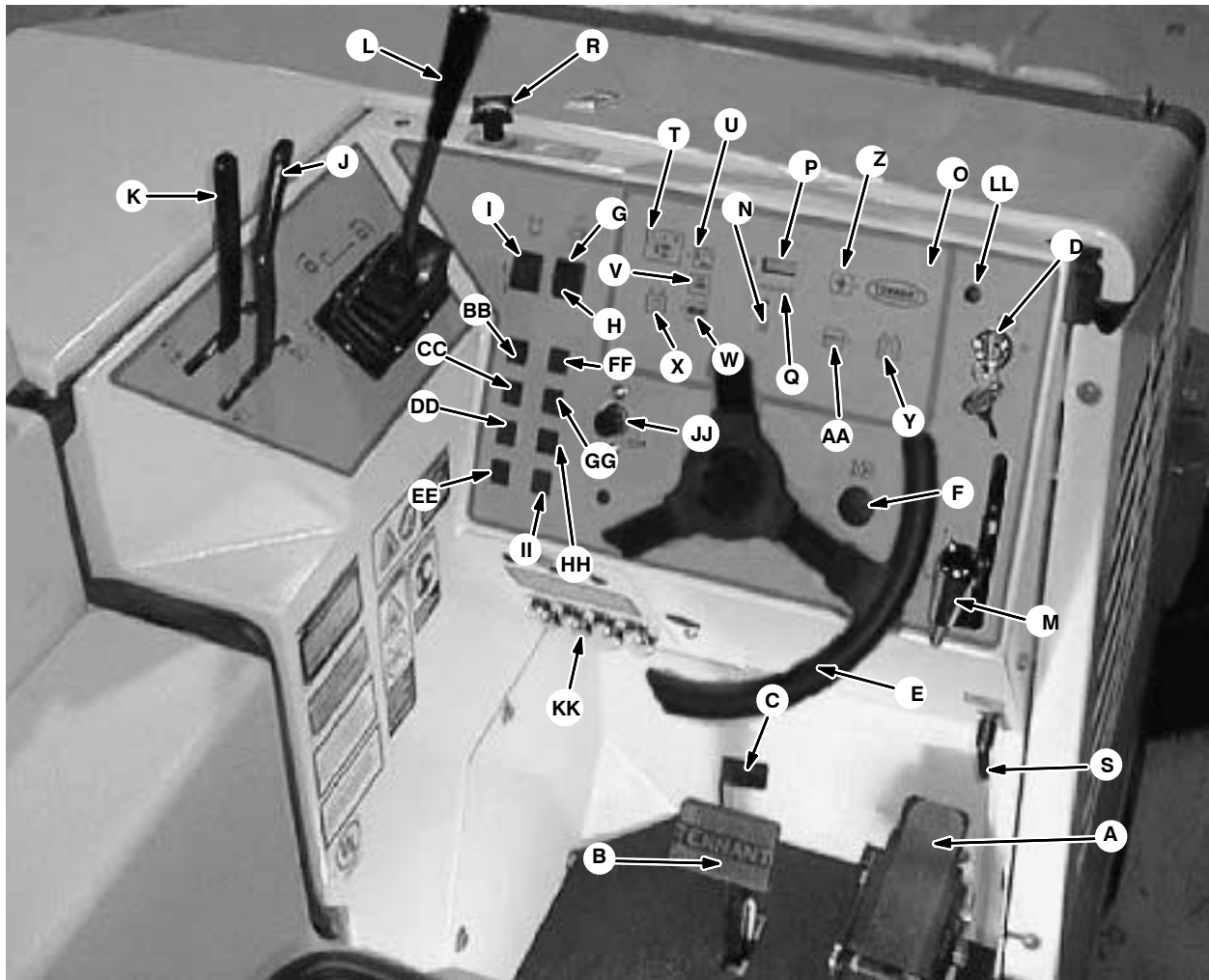

- | | |
|---|---|
| A. Directional pedal | U. Squeegee switch |
| B. Brake pedal | V. Edge scrub switch (option) |
| C. Parking brake pedal | W. ES switch (option) |
| D. Ignition switch | X. Detergent pump switch (option) |
| E. Steering wheel | Y. Engine speed switch |
| F. Steering column tilt lever (option) | Z. Sweeping vacuum fan switch |
| G. Operating lights switch | AA. Filter shaker switch |
| H. Operating/hazard light switch (option) | BB. Charging system light |
| I. Solution flow switch | CC. Engine oil pressure light |
| J. Hopper door lever | DD. Engine water temperature light |
| K. Hopper lever | EE. Hopper temperature light - Thermo Sentry™ |
| L. Main sweep brush lever | FF. OK light |
| M. Side brush lever | GG. Clogged filter light (option) |
| N. Recovery tank full indicator | HH. Hopper door closed light (option) |
| O. Control panel | II. Hydraulic filter bypass light (option) |
| P. Hourmeter | JJ. Horn button |
| Q. Fuel level gauge | KK. Circuit breakers |
| R. Main sweep brush down pressure | LL. Glow plugs light |
| S. Side brush down pressure handle | |
| T. Scrub switch | |

OPERATION

OPERATION OF CONTROLS

DIRECTIONAL PEDAL

The directional pedal controls direction of travel and the propelling speed of the machine. Change the speed of the machine with the pressure of your foot; the harder you press the pedal, the faster the machine travels.

Forward: Press the top of the directional pedal with the toe portion of your foot.



Reverse: Press the bottom of the directional pedal with the heel of your foot.



Neutral: Take your foot off the directional pedal and it will return to the neutral position.



BRAKE PEDAL

The brake pedal stops the machine.

Stop: Take your foot off the directional pedal and let it return to the neutral position. Step on the brake pedal.

**PARKING BRAKE PEDAL**

The parking brake pedal sets and releases the front wheel brakes.

Set: While pressing the brake pedal as far as it will go, set the parking brake by pressing the parking brake pedal with the toe portion of your foot.

FOR SAFETY: Before leaving or servicing machine; stop on level surface, set parking brake, turn off machine and remove key.

Release: Press on the brake pedal to unlock the parking brake pedal.

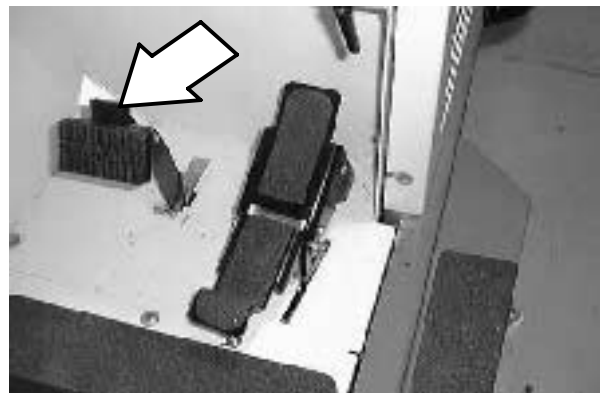

OPERATION

IGNITION SWITCH

The ignition switch starts and stops the engine with a key.

FOR SAFETY: When starting machine, keep foot on brake and directional pedal in neutral.

Preheat the glow plugs: Turn the key all the way counter-clockwise and hold it there until the glow plug light goes out.

Start: Turn the key all the way clockwise. Release the key as soon as the engine starts.

Stop: Turn the key counter-clockwise.



STEERING WHEEL

The steering wheel controls the machine's direction. The machine is very responsive to the steering wheel movements.

Left: Turn the steering wheel to the left.

Right: Turn the steering wheel to the right.

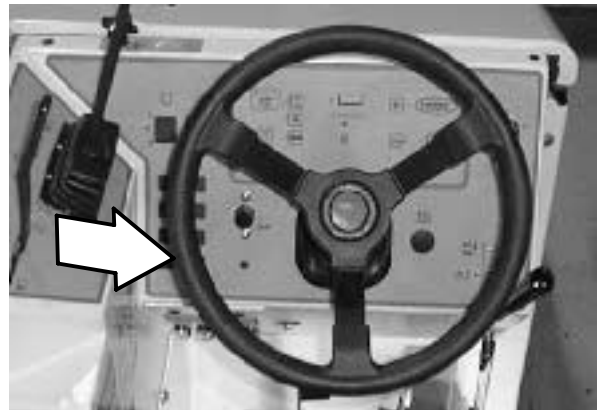

STEERING COLUMN TILT LEVER (OPTION)

The steering column tilt handle controls the angle of the steering wheel.

Adjust: Pull out the tilt handle, then move the wheel to the desired position and release the tilt handle.

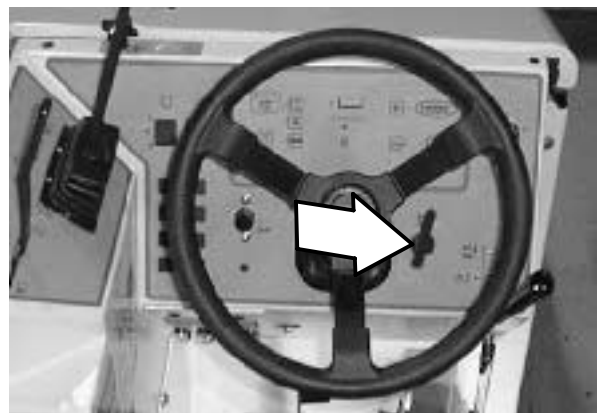

The main sweep brush lever controls the position and rotation of the main sweeping brush.

Main brush down and on: Pull the lever back and to the right, then allow it to move forward into the **main brush down and on** position.

Main brush up and off: Pull the lever back and to the left into the **main brush up and off** position. The brush will raise, stop rotating, and the vacuum fan will shut off automatically.

NOTE: The filter shaker will automatically shake the filter for 15 seconds each time the main brush is raised.



MAIN SWEEP BRUSH DOWN PRESSURE KNOB

The main brush down pressure knob changes the amount of contact the main brush has with the surface being swept.

Increase: Turn the main brush down pressure knob counter-clockwise.

Decrease: Turn the main brush down pressure knob clockwise.



OPERATION

SIDE BRUSH LEVER

The side brush lever controls the position and rotation of the side brush.

Side brush down and on: Pull the lever back and to the right, then allow it to move forward into the **side brush down and on** position. The brush will automatically start rotating.

Side brush up and off: Pull the lever back and to the left into the **side brush up and off** position.

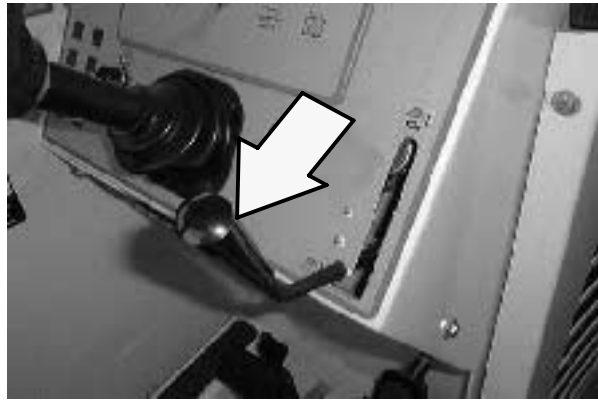

SIDE BRUSH DOWN PRESSURE HANDLE

The side brush down pressure handle changes the amount of contact the side brush has with the surface being swept.

Increase: Turn the side brush down pressure handle counter-clockwise.

Decrease: Turn the side brush down pressure handle clockwise.



HOPPER LEVER

The hopper lever raises and lowers the hopper.

Hopper up: Pull and hold the hopper lever backward until the hopper reaches the desired height.

Hold: Release the hopper lever into the middle position.

 **WARNING: Raised hopper may fall. Engage hopper support bar.**

Hopper down: Push the hopper lever forward until the hopper has lowered completely.

NOTE: The main sweeping brush, side brush, and sweep vacuum fan will stop operating when the hopper is raised. If the sweep vacuum fan, side brush switch, or the main brush switch is pressed while the hopper is raised, none of the sweeping operations will activate.



HOPPER DOOR LEVER

The hopper door lever opens and closes the hopper door.

Hopper door close: Pull and hold the hopper door lever backward for approximately four seconds or until the hopper door closed light (option) on the dashboard illuminates.

Hopper door open: Push the hopper door lever forward to the detent position.

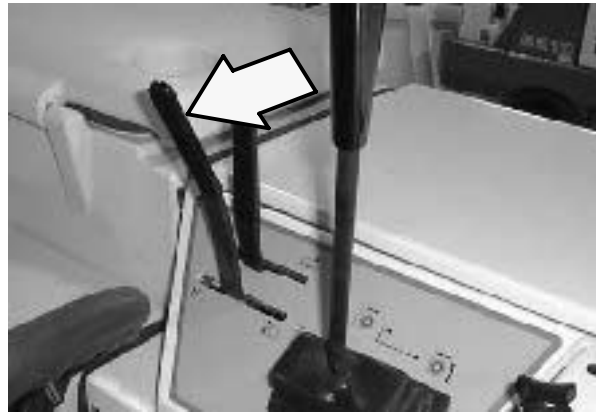

CONTROL PANEL

The control panel controls all scrubbing operations and the sweeping vacuum fan and filter shaker motor.



HOURLMETER

The hourmeter records the number of hours the machine has been operated. Check the hourmeter regularly; this information is used to determine when to perform routine machine maintenance.

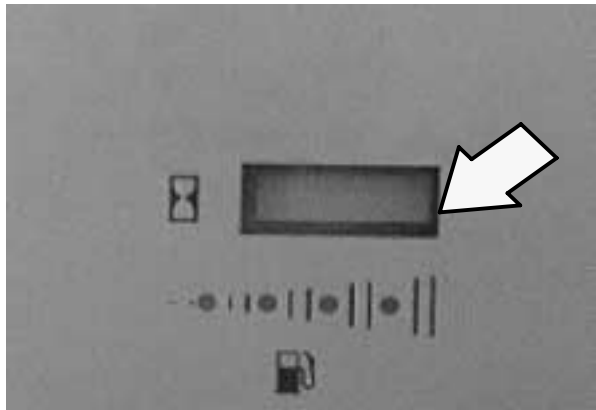

FUEL LEVEL GAUGE

The fuel level gauge indicates the amount of fuel remaining in the fuel tank. As the fuel is consumed, the indicator lights will move across the display from right to left. When only the light on the far left is lit, the fuel tank is nearly empty. Refill the fuel tank as soon as possible.

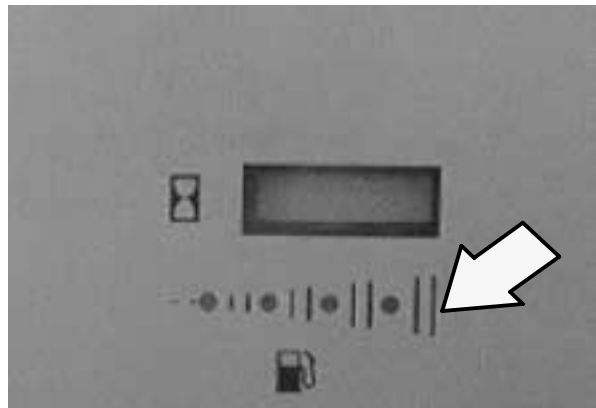

OPERATION

SCRUB SWITCH

The scrub switch controls the scrubbing operations. The scrub switch also sets the scrub brush pressure.

The scrubbing operations include the functions described below. When the machine is moving forward, the scrub head lowers and the scrub brushes activate. The scrub head will move into the edge scrub position if the edge scrub switch (option) is pressed. The rear squeegee will lower and the vacuum fan will start. The solution system will start, if the solution flow switch is on. Also, the optional ES system and detergent pump will start if the switches are on. The engine speed will change to *fast*.

Start: Press the scrub switch.

Stop: Press the scrub switch again.

Scrub brush pressure: Press and hold the scrub switch. The brush pressure will scroll through three settings. The pressure setting selected when the switch is released will be the new default brush pressure setting.

The brush pressure can be set into three different positions. Under normal conditions, the brush pressure should be set in the minimum settings (one or two indicators above switch are lit). Under heavy grime conditions, the brush pressure should be set in the maximum setting (three indicators above switch are lit). Travel speed and floor conditions will affect the scrubbing performance.

NOTE: The brush pressure setting, and the detergent flow rate will default to the last settings used when the scrubbing operations are started again.

NOTE: The scrub head will raise when the directional pedal is in the neutral position. The rear squeegee will raise when the directional pedal is in the reverse position.

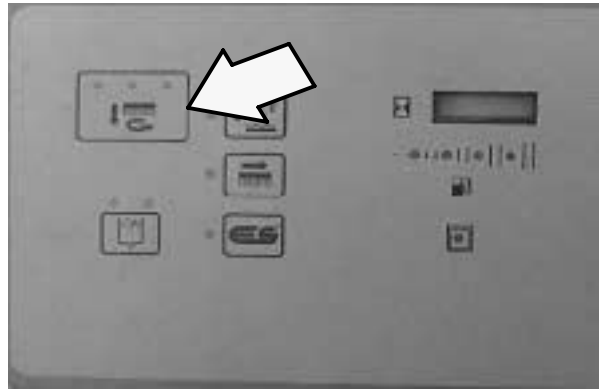

SQUEEGEE SWITCH

The squeegee switch controls the position of the rear squeegee. The rear squeegee can be operated separately from the scrub brushes for the purpose of double scrubbing.

Double scrubbing is the process of making two or more passes over a heavily soiled area. The first pass is made with the rear squeegee raised to allow the solution to soak into the floor.

Lower: Press the squeegee switch. The indicator light next to the switch will illuminate.

Raise and stop: Press the squeegee switch. The indicator next to the switch goes off. There will be a slight delay before the vacuum shuts off.

NOTE: The rear squeegee lowers and scrubbing vacuum starts automatically when the scrubbing operations start.

NOTE: The rear squeegee will raise and the scrubbing vacuum will shut off after a short delay when the machine travels in reverse.

NOTE: The rear squeegee will raise and the scrubbing vacuum fan will shut off after a short delay when the scrubbing operations are shut off.

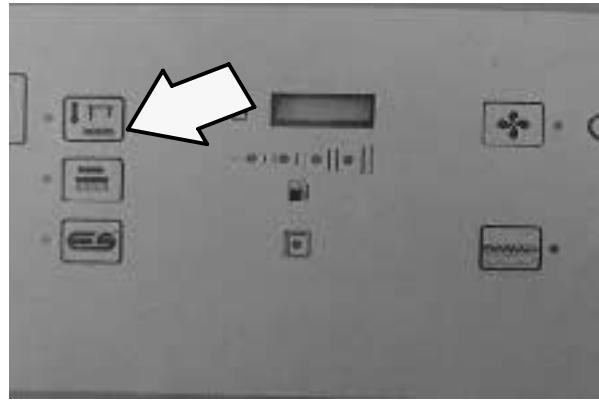

EDGE SCRUB SWITCH (OPTION)

The edge scrub switch extends the scrub head to the right to allow close edge scrubbing.

Edge scrub out: Press the edge scrub switch during scrubbing. The indicator light next to the switch will illuminate.

Edge scrub in: Press the edge scrub switch. The indicator light next to the switch will go out.

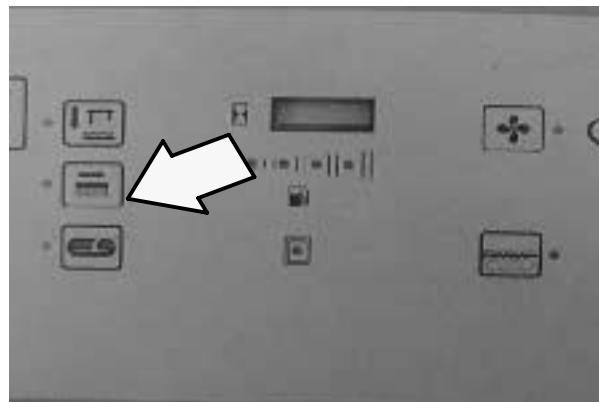

OPERATION

ES SWITCH (OPTION)

The ES switch turns the extended scrub system on and off. When the machine is started, the ES switch will default to the last setting used.

On: Press the ES switch. The indicator light next to the switch will illuminate.

Off: Press the ES switch. The indicator light next to the switch will go out.

NOTE: When the ES switch is on and the water levels in the tanks are at the proper levels, there will be a slight delay before the ES pump turns on.

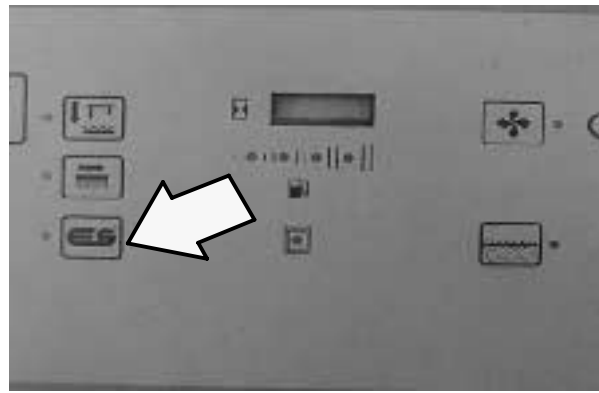

RECOVERY TANK FULL INDICATOR

The recovery tank full indicator will illuminate when the recovery tank is full of recovered solution. All scrubbing functions will stop automatically soon after the recovery tank becomes full. Drain the recovery tank as soon as possible after the indicator illuminates. The indicator light will remain lit until the tank is drained.



DETERGENT PUMP SWITCH (OPTION)

The detergent switch controls the amount of detergent that flows to the floor while scrubbing. When the machine is started, the detergent pump switch will default to the last setting used.

NOTE: *The detergent pump switch will not activate unless the main scrub brushes are active, the machine is moving forward, and the solution switch is in the high or low position.*

High: Press and hold the detergent pump switch until both indicator lights above the switch are illuminated. Release the switch.

Low: Press and hold the detergent pump switch until one indicator light above the switch is illuminated. Release the switch.

Off: Press and release the detergent pump switch until none of the indicator lights above the switch are lit.

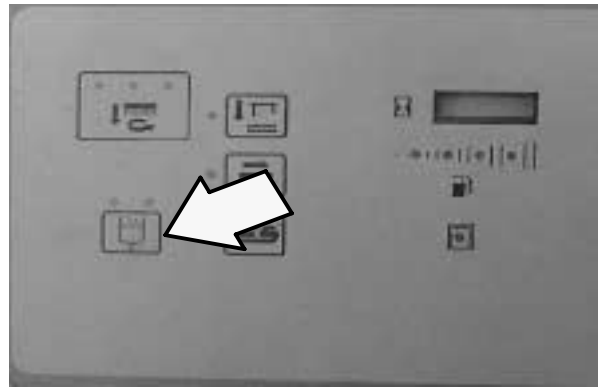

ENGINE SPEED SWITCH

The engine speed switch controls the engine governed speed. When the left indicator light above the switch is illuminated, the engine is in *idle* speed. When the right indicator light above the switch is illuminated, the engine is in *fast* speed.

Idle speed: The engine will automatically start in *idle* speed. To return the engine to *idle* from the *fast* engine speed, press and hold the engine speed switch until the left indicator illuminates. The scrubbing and sweeping operations will turn off automatically.

NOTE: *If the scrubbing operations are on when the idle speed is selected, the rear squeegee will raise and the scrubbing vacuum fan will shut off.*

Fast speed: Press and hold the engine speed switch until the right indicator light illuminates. This speed is for transporting, sweeping, and scrubbing.

NOTE: *The engine will automatically operate in the fast speed when the scrubbing or sweeping operations are started.*

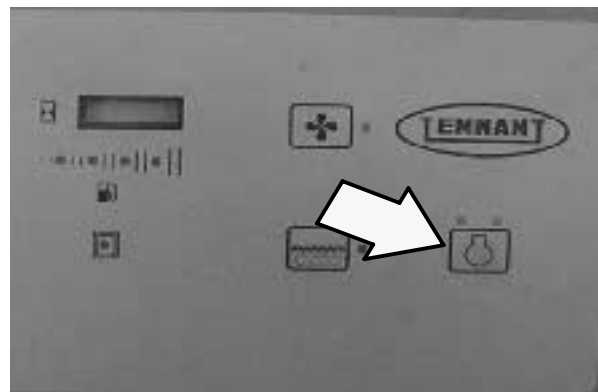

OPERATION

SWEEPING VACUUM FAN SWITCH

The sweep vacuum fan switch starts and stops the sweep vacuum fan. Do not operate the vacuum fan when sweeping in wet conditions.

Start: Press the switch. The indicator next to the switch will illuminate.

Stop: Press the switch. The indicator light next to the switch will go out.

NOTE: The sweep vacuum fan activates automatically when the main sweeping brush starts operating. The sweep vacuum fan will not activate unless the main sweeping brush is operating.

NOTE: The sweep vacuum fan will not start if the hopper is raised, even slightly. If the sweep vacuum fan switch is pressed while the hopper is raised, the sweep vacuum will not start.

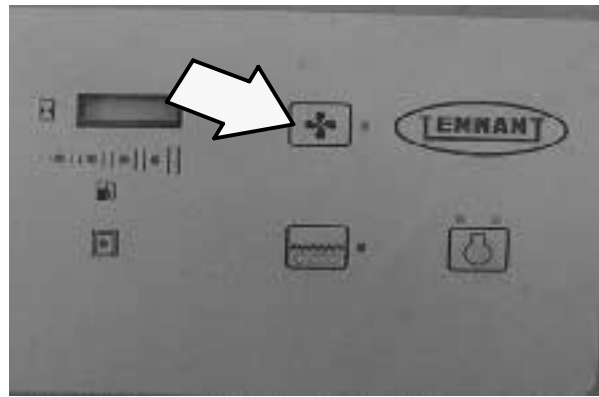

FILTER SHAKER SWITCH

The filter shaker switch starts the hopper dust filter shaker. The shaker automatically operates for 30 seconds.

Start: Press the filter shaker switch. The indicator light will remain on while the filter shaker is operating.

NOTE: The filter shaker will activate automatically for a short time each time the sweeping operations are stopped. The filter shaker will not operate while the sweeping or vacuum system is operating.

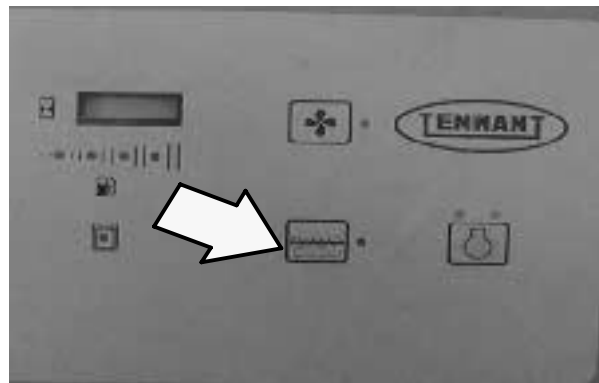

OPERATING LIGHTS SWITCH

The operating lights switch powers the headlights and taillights on and off.

On: Press the top of the operating lights switch.

Off: Press the bottom of the operating lights switch.

**OPERATING/HAZARD LIGHT SWITCH (OPTION)**

The operating/hazard light switch powers the headlights and taillights, and the revolving hazard light (option) on and off.

Operating lights on: Press the top of the hazard light switch.

Operating lights/Hazard light (option) on: Press the bottom of the hazard light switch.

All lights off: Set the the hazard light switch in the middle position.

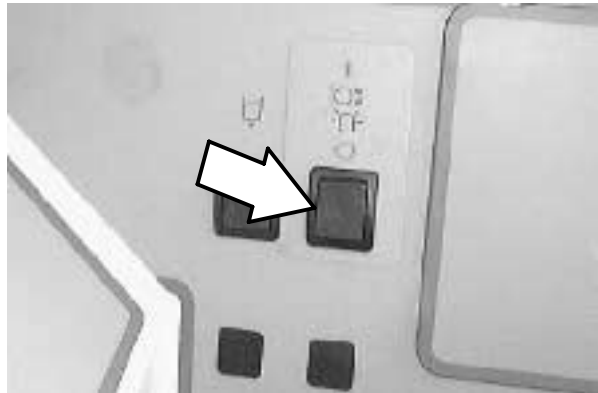
**SOLUTION FLOW SWITCH**

The solution flow switch controls the amount of solution that flows to the floor while scrubbing.

(1) Low: Press the top of the switch. Use this flow rate for smooth floors and light dirt.

(0) Off: Press the middle of the switch.

(2) High: Press the bottom of the switch. Use this flow rate for rough floors and heavy or compacted dirt.

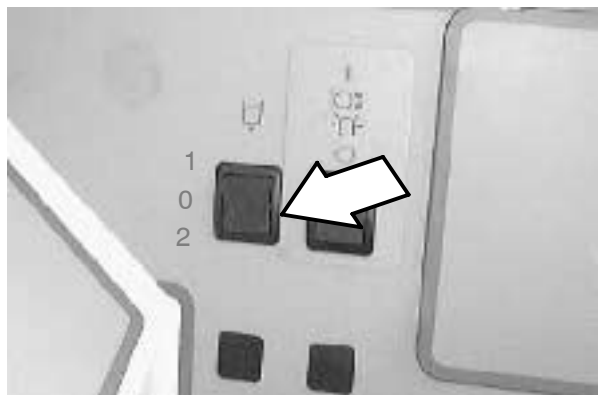

OPERATION

MANUAL FLOW VALVE

The machine is equipped with a manually adjustable solution flow valve that is located on the right side of the scrubhead. The valve can be adjusted to dispense either more or less solution. Contact your TENNANT representative with solution flow rate questions.

Maximum flow: Turn the flow lever to the horizontal position.

Minimum flow: Turn the flow lever to the vertical position.

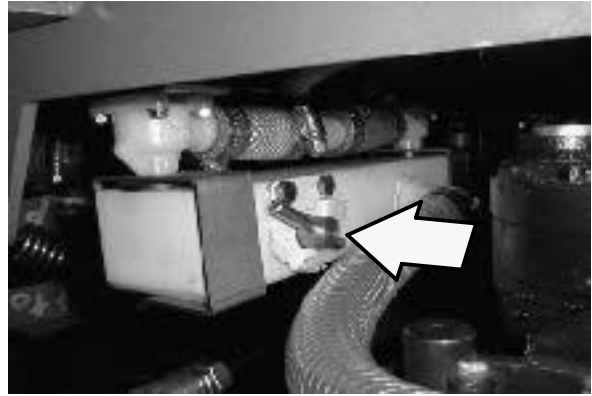

CHARGING SYSTEM LIGHT

The charging system light will illuminate when the alternator is not operating within the normal range. If the light illuminates stop the machine immediately, then find the problem and have it corrected.

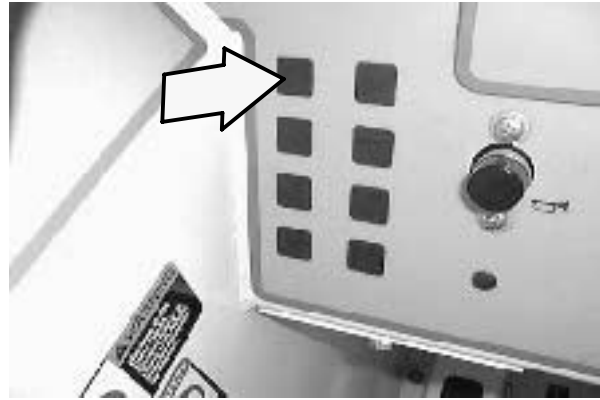
**ENGINE OIL PRESSURE LIGHT**

The engine oil pressure light will illuminate when the engine oil pressure falls below 40 kPa (5 psi). In this situation, an alarm will sound until the oil pressure problem is corrected. If the light illuminates stop the machine immediately, then find the problem and have it corrected.

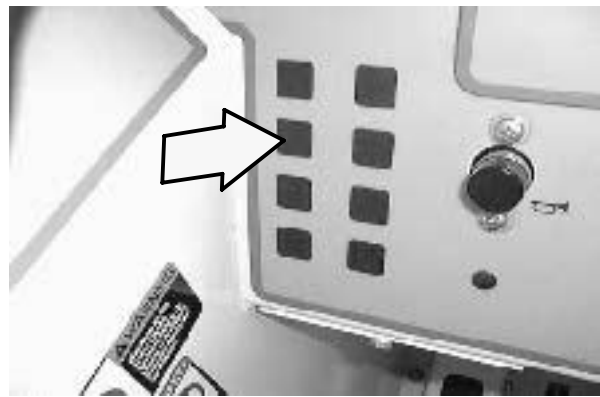
**ENGINE WATER TEMPERATURE LIGHT**

The engine water temperature light will illuminate when the temperature of the engine coolant is more than 107° C (225° F). If the light illuminates stop the machine immediately, then find the problem and have it corrected.

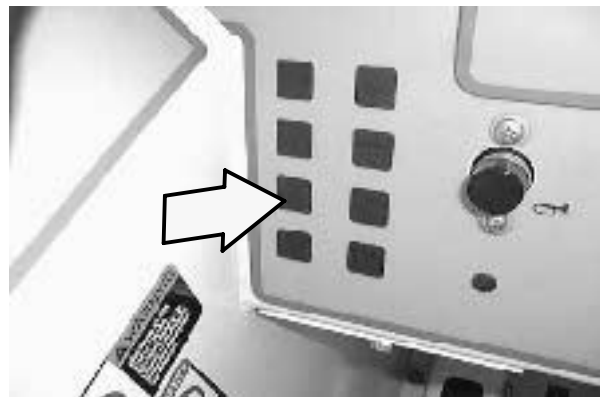

OPERATION

HOPPER TEMPERATURE LIGHT - THERMO SENTRY

The hopper temperature light will illuminate when there is too much heat, possibly from a fire, in the hopper. The Thermo Sentry will stop the sweeping vacuum fan. If the light illuminates stop the machine immediately, then find the problem and have it corrected.



OK LIGHT

Each time the key switch is turned to the on position the instrument panel will run a self-diagnostic test. If the instrument panel passes the test, the OK light will illuminate.



CLOGGED FILTER LIGHT (OPTION)

The clogged filter light will illuminate when the hopper dust filter is clogged.

To clean the filter, press the filter shaker switch. If the clogged filter light remains lit, manually clean the hopper dust filter. See *HOPPER DUST FILTER* in the *MAINTENANCE* section of this manual.

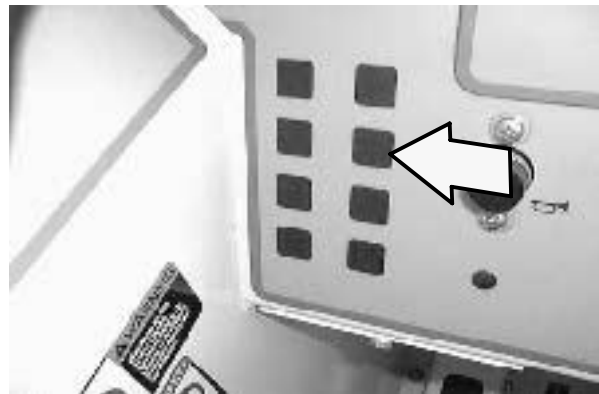

HOPPER DOOR CLOSED LIGHT (OPTION)

The hopper door closed light will illuminate when the hopper door is closed.

Make sure the the hooper door is open (the light will be out), while sweeping.

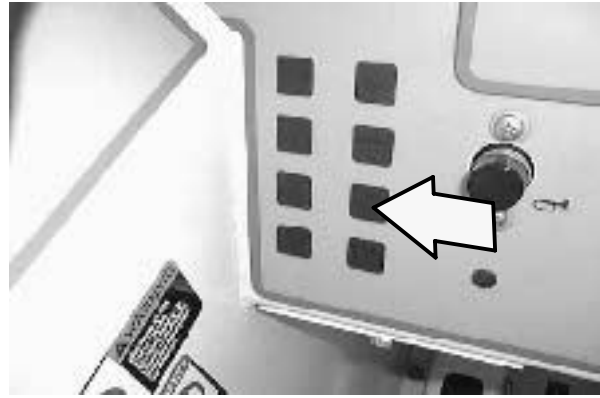
**HYDRAULIC FILTER BYPASS LIGHT (OPTION)**

The hydraulic filter bypass light will illuminate when the hydraulic filter becomes clogged. If the light illuminates stop the machine immediately, then change the hydraulic filter and hydraulic fluid as soon as possible.

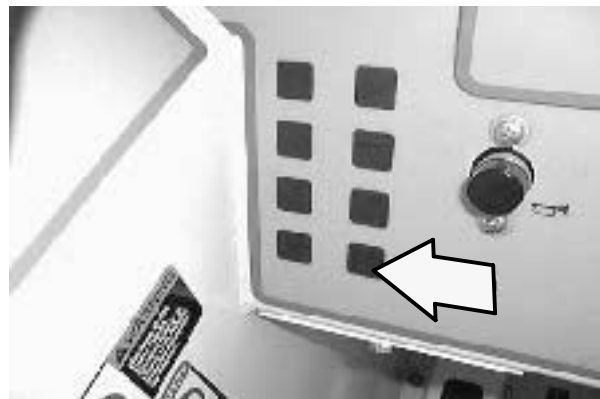
**HORN BUTTON**

The horn button operates the horn.

Sound: Press the button.



OPERATION

CIRCUIT BREAKERS

The circuit breakers are resettable electrical circuit protection devices. Their design stops the flow of current in the event of a circuit overload. Once a circuit breaker is tripped, it must be reset manually. Press the reset button after the breaker has cooled down.

If the overload that caused the circuit breaker to trip is still there, the circuit breaker will continue to stop current flow until the problem is corrected.

The circuit breakers are located in the operator compartment.

The chart lists the circuit breakers and the electrical components they protect.

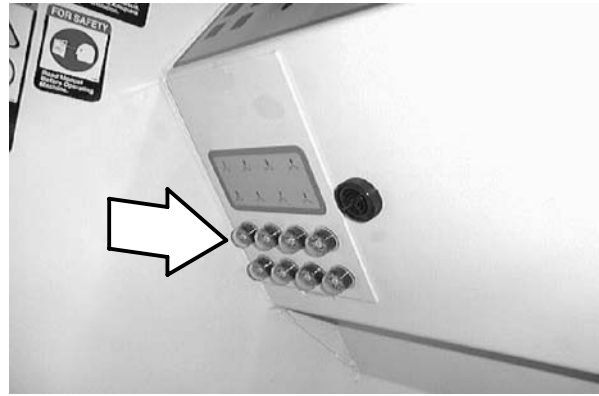

Circuit Breaker	Rating	Circuit Protected
CB-1	15 A	Horn
CB-2	15 A	Ignition
CB-3	15 A	Headlights / Taillights
CB-4	5 A	Logic Power
CB-5	15 A	Sweeping
CB-6	15 A	Scrubbing Accessories
CB-7	15 A	Scrubbing Brushes
CB-8	15 A	Filter Shaker Motor

FUSE

The fuse is a one-time protection device designed to stop the flow of current in the event of a circuit overload. Never substitute higher value fuses than specified.

The fuse is located in the operator compartment. Remove the circuit breaker panel to gain access to the fuse.

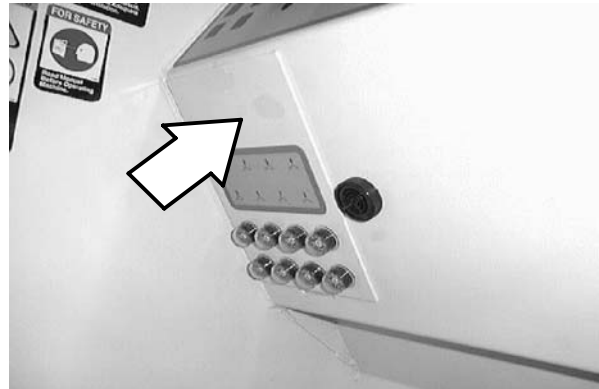

Fuse	Rating	Circuit Protected
FU-1	40 A	Glow plugs

OPERATOR SEAT

The standard operator seat is a fixed back style.

Remove the seat mounting bracket, then remove the seat from the bracket and re-mount it in different holes to adjust the seat position.

**ADJUSTABLE SEAT (OPTION)**

The optional adjustable seat has a position adjustment lever that allows the operator to move the seat forward or backward to the desired position.

Adjust: Pull the lever outward and slide the seat to the desired position, then release the lever.

**DELUXE SUSPENSION SEAT (OPTION)**

The deluxe suspension seat can be adjusted according to the operator's weight, desired back rest angle, and desired front-to-back position.

The operator weight adjustment lever has three different positions: lightweight, middleweight, and heavyweight.

Adjust: Pull the lever up for the lightweight position. Move the lever to middle for the middleweight position. Push the lever down for the heavyweight position.



The back rest angle knob adjusts the angle of the back rest.

Adjust: Turn the knob clockwise to decrease or counter-clockwise to increase the angle of the back rest.

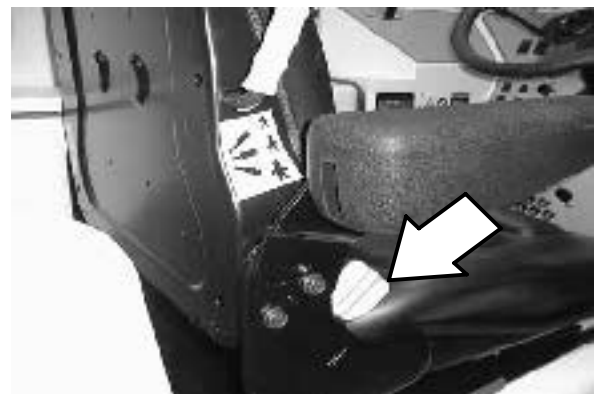

OPERATION

The seat position lever adjusts the seat forward or backward.

Adjust: Pull the lever outward and slide the seat to the desired position, then release the lever.



HOPPER SUPPORT BAR

The hopper support bar is located on the operator's side of the hopper. The hopper support bar holds the hopper in the raised position to allow work under the hopper. **DO NOT** rely on the machine hydraulic system to keep the hopper raised.



**WARNING: Raised hopper may fall.
Engage hopper support bar.**

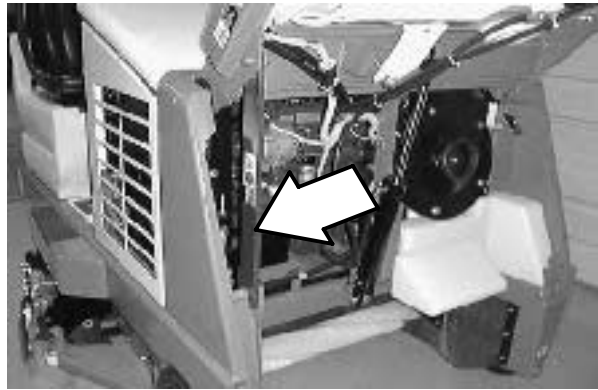

ENGINE COVER GAS SPRING

The engine cover gas spring is located underneath the engine cover. The gas spring holds the engine cover in the raised position to allow work on the engine.

To close the engine cover, push the lower portion of the gas spring in line with the top portion, and push the engine cover downward.

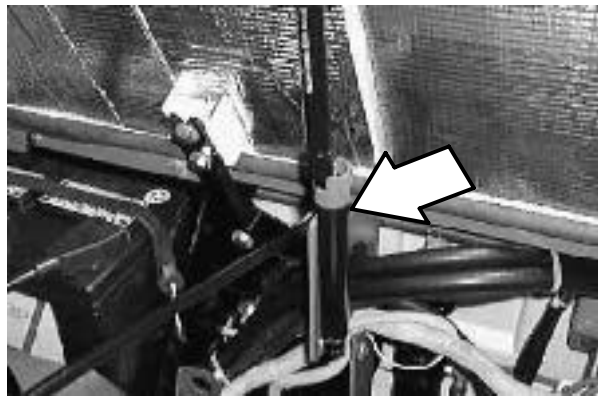

LATCHES

The solution tank cover and the side and top engine doors are secured with latches.

Open: Press the raised part of the latch.

Close: Press the flat part of the latch.

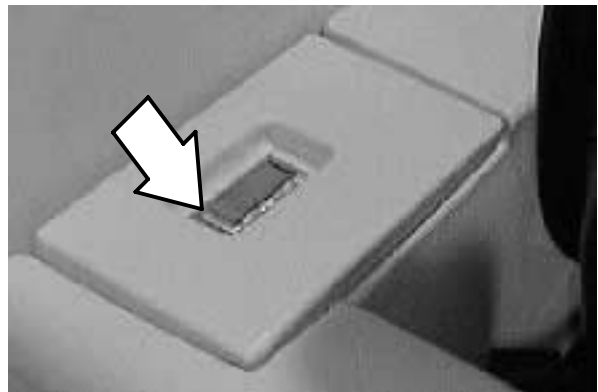

HOW THE MACHINE WORKS

The steering wheel controls the direction of machine travel. The directional pedal controls the speed and forward/reverse direction. The brake pedal slows and stops the machine.

The side brush sweeps debris into the path of the main sweeping brush. The main brush sweeps debris from the floor into the hopper. The vacuum system pulls dust and air through the hopper and the hopper dust filter.

Water and detergent from the solution tank flow to the floor through a solution valve to the scrub brushes. The brushes scrub the floor. As the machine is moved forward the squeegee wipes the dirty solution off the floor, which is then picked up and drawn into the recovery tank.

When using the ES mode, the dirty solution in the recovery tank is filtered and returned to the solution tank to be reused.

When sweeping and scrubbing is finished, clean the hopper dust filter, empty the hopper, and drain and clean the recovery tank. If using the ES system, drain and clean the solution tank, and clean the ES filter.

PRE-OPERATION CHECKLIST

- Check the engine oil level.
- Check the engine coolant level.
- Check the radiator and hydraulic cooler fins for debris.
- Check the hydraulic fluid level
- Check the air filter indicator.
- Check the skirts and seals for damage and wear.
- Check the condition of the sweeping and scrubbing brushes. Remove any string, banding, plastic wrap, or other debris wrapped around them.
- Check the sweeping brush patterns for adjustment.
- Check the condition of the hopper dust filter and seals. Clean as required.
- Check the tank cover seals for damage and wear.
- Clean the vacuum fan inlet filter.
- Check the squeegees for damage, wear and for deflection adjustment.
- Check the vacuum hose for debris or blockage.
- ES machines; check the detergent tank level.
- Drain and clean the recovery tank.
- ES machines; drain and clean the solution tank and ES filter. Rinse level sensors.
- Check the brakes and steering for proper operation.
- Check the fuel level
- Empty the debris hopper.
- Check the service records to determine maintenance requirements.

STARTING THE MACHINE

1. You must be in the operator's seat with the directional pedal in neutral, and your foot on the brake pedal or with the parking brake set.

FOR SAFETY: When starting machine, keep foot on brake and directional pedal in neutral.

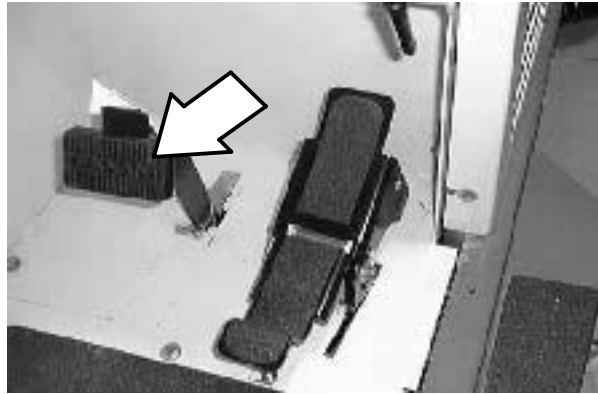

2. Turn the ignition switch key all the way counter-clockwise and hold it there until the glow plugs light above the switch goes out.



3. Turn the ignition switch key clockwise until the engine starts.

NOTE: Do not operate the starter motor for more than 10 seconds at a time or after the engine has started. Allow the starter to cool between starting attempt or damage to the starter motor may occur.



4. Allow the engine and hydraulic system to warm up three to five minutes.



WARNING: Engine emits toxic gases. Severe respiratory damage or asphyxiation can result. Provide adequate ventilation. Consult with your regulatory authorities for exposure limits. Keep engine properly tuned.

5. Release the machine parking brake.



6. Drive the machine to the area to be cleaned.

SWEEPING, SCRUBBING, AND BRUSH INFORMATION

Pick up oversized debris before sweeping. Flatten or remove bulky cartons from aisles before sweeping. Pick up pieces of wire, twine, string, or anything that could become entangled in the brush or brush plugs.

Plan the sweeping and scrubbing in advance. Try to arrange long runs with minimum stopping and starting. Sweep debris from very narrow aisles into main aisles ahead of time. Do an entire floor or section at one time. Drive as straight as possible. Overlap the brush paths. Avoid bumping into posts or scraping the sides of the machine.

Avoid turning the steering wheel abruptly, except in emergencies. The machine is very responsive to the movement of the steering wheel.

Adjust the machine speed, scrub brush pressure, and detergent and solution flow as required when scrubbing. Use the minimum scrub brush pressure and solution flow for the best scrubbing results. Machines with the edge clean option have the ability to scrub against walls and edges.

When the recovery tank is almost full, the recovery tank full indicator will blink for almost a minute before the scrubbing system shuts off. The recovery tank will have to be drained and cleaned. Refill the solution tank with clean water and detergent and continue cleaning.

For best results, use the correct brush type for your sweeping and scrubbing application. The following are recommendations for main sweeping, scrubbing, and side brush applications.

Polypropylene 8-double row main sweep brush – Superior pick-up of sand, gravel, and paper litter. Polypropylene retains its stiffness when wet, and can be used indoors or out with equal performance. Not recommended for high-temperature debris.

Polypropylene and Wire 8-double row main sweep brush – The wire bristles loosen slightly packed soilage and heavier debris. The polypropylene bristles sweep up the debris with excellent hopper loading.

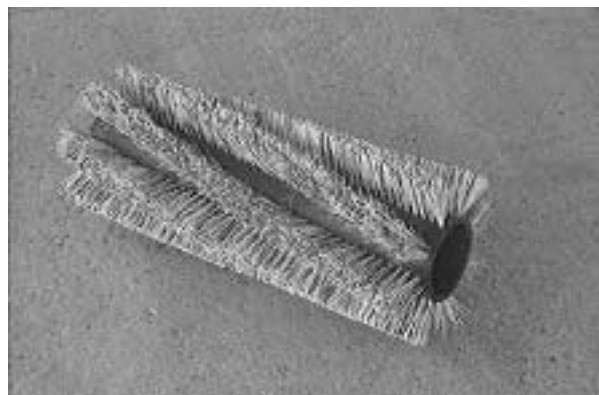

Polyester 8-double row main sweep brush –

Polyester combines the durability of nylon with the moisture resistance of polypropylene.

Polyester 24-row main sweep brush –

Polyester combines the durability of nylon with the moisture resistance of polypropylene. This high density brush is recommended for applications that sweep heavy accumulations of fine dust, sand, or other similar material.

Polypropylene side brush – A good general purpose brush for sweeping of light to medium debris in both indoor and outdoor applications. This brush is recommended when bristles may get wet.

Nylon side brush – A longer life, general purpose brush that is recommended for rough surfaces.

Flat wire side brush – Recommended for outside and curb-side sweeping where soilage is heavy or compacted. The stiff wire bristles dig out soilage. This brush is also recommended for foundry sweeping when heat may melt synthetic bristles.

Non-scuff polypropylene scrub brush – This brush uses a softer, general -purpose poly bristle to lift lightly compacted soilage, without scuffing high-gloss coated floors.

Nylon scrub brush – Recommended for scrubbing coated floors. Cleans without scuffing.

Super abrasive bristle scrub brush – Nylon fiber impregnated with abrasive grit to remove stains and soilage. Strong action on any surface, performs well on debris build-up, grease, or tire marks.

Black high-productivity stripping pads – Use these 12 mm (0.50 in) pads for aggressive stripping of floor finishes or sealers, or heavy-duty scrubbing.

Brown stripping pads – Use these pads for light stripping of floor finishes or sealers.

Blue scrubbing pads – Use these pads for medium to heavy-duty scrubbing on industrial floor surfaces.

Red buffing pads – Use these pads for light-duty scrubbing on industrial floor surfaces.

White polishing pads – Use these pads for surface cleaning of highly-polished or burnished floors.



OPERATION

SWEEPING

1. Start the engine.
2. Push the hopper door lever forward to the detent position.



3. Pull the main brush lever back and to the right, then allow it to move forward into the **main brush down and on** position. The main brush will start rotating automatically.



4. Pull the side brush lever back and to the right, then allow it to move forward into the **side brush down and on** position. The side brush will start rotating automatically.

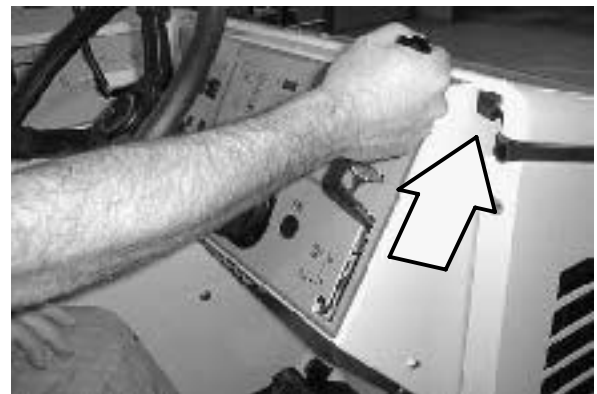

5. Sweep as needed.

STOP SWEEPING

1. Pull the main brush lever backward and to the the left into the **main brush up and off** position.



2. Pull the side brush lever backward and to the the left into the **side brush up and off** position.

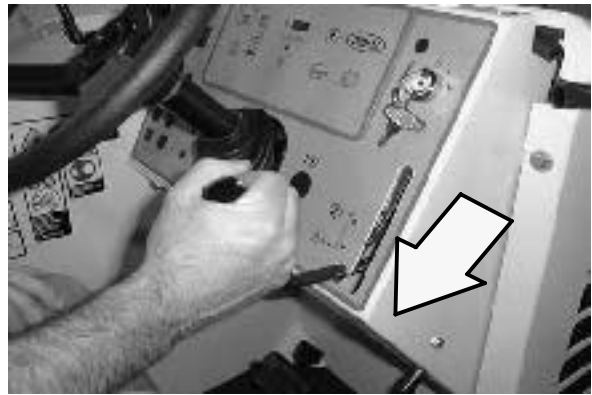

3. Pull and hold the hopper door lever back for approximately four seconds, or until the hopper door closed light (option) on the dashboard illuminates.



EMPTYING THE HOPPER

1. Stop sweeping.

NOTE: The filter shaker will automatically shake the filter for a short time each time the main brush is raised.

2. Slowly drive the machine to the debris site or debris container.
3. Pull and hold the hopper door lever back for approximately four seconds, or until the hopper door closed light (option) on the dashboard illuminates.



4. Press the filter shaker switch. The shaker automatically operates for 30 seconds. The indicator light will remain on while the filter shaker is operating.

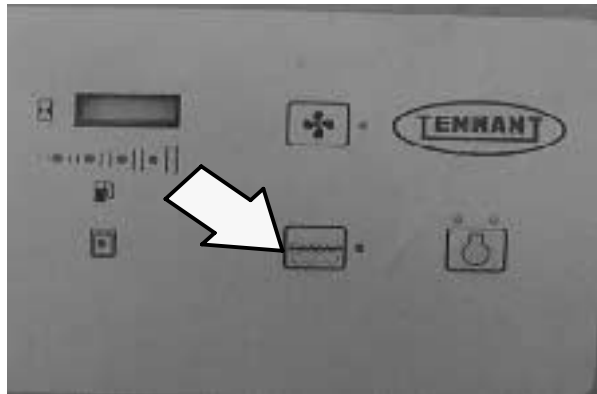

5. After the filter shaker stops, pull the hopper lever backward to raise the hopper.

FOR SAFETY: When using machine, make sure adequate clearance is available before raising hopper.

NOTE: Be aware that the minimum ceiling height needed to high dump the hopper is 2286 mm (90 in).

FOR SAFETY: When using machine, move machine with care when hopper is raised.

6. Drive the machine up to the debris container.

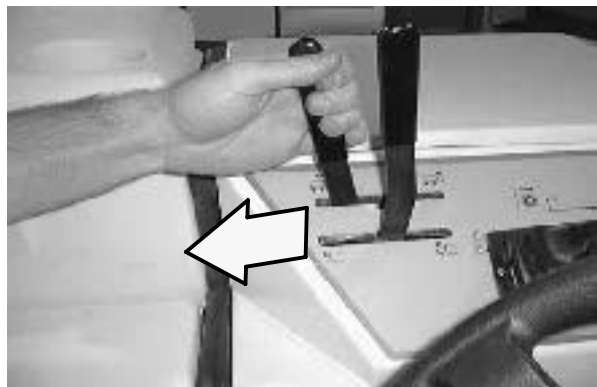

7. Push and hold the hopper door lever forward until the hopper door is fully open (about 4 seconds).
8. Allow all of the debris in the hopper to fall into the debris container.



9. Pull and hold the hopper door lever back for approximately four seconds, or until the hopper door closed light (option) on the dashboard illuminates.
10. Slowly back the machine away from the debris site or debris container when all of the debris has fallen out of the hopper.

FOR SAFETY: When using machine, use care when reversing machine.



11. Push and hold the hopper lever forward until the hopper is completely lowered.

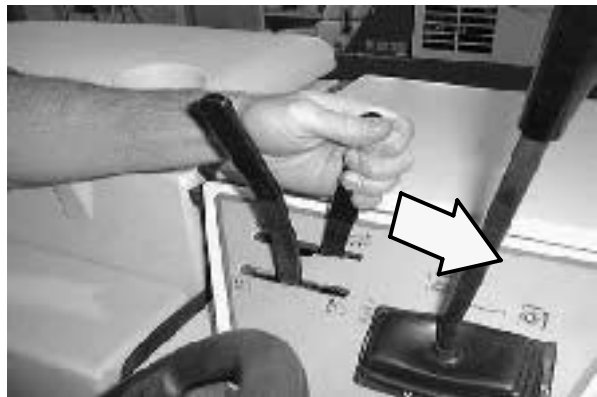

12. Push the hopper door lever forward to the detent position.



FILLING THE TANKS

1. Start the machine.

FOR SAFETY: When starting machine, keep foot on brake and directional pedal in neutral.

2. Drive the machine to the filling site.
3. Shut the engine off.
4. Set the parking brake.



5. Open the solution tank cover. Measure and pour in the correct amount of detergent. Fill the solution tank with water up to the FULL line near the top of the tank.

FOR SAFETY: When using machine, follow mixing and handling instructions on chemical containers.

NOTE: Floor conditions, water condition, amount of soilage, type of soilage, and brush pressure all play an important role in determining the type and concentration of detergent to be used. For specific recommendations, contact your TENNANT representative.



WARNING: Flammable materials can cause an explosion or fire. Do not use flammable materials in tank(s).

6. Remove the detergent tank (option) lid. Fill the tank to just below the top. Be sure to use only the proper detergent for your scrubbing application. Put the lid back on the detergent tank.



WARNING: Flammable materials can cause an explosion or fire. Do not use flammable materials in tank(s).

NOTE: Floor conditions, water condition, amount of soilage, type of soilage, and brush action all play an important role in determining the type and concentration of detergent used. For specific recommendations, contact your TENNANT representative.

ES mode with auto-fill: Connect the hose from the water source to the auto-fill connection on the machine. Turn the ignition key to the on position and turn on the water source. The auto-fill will automatically fill the tanks to the proper level for ES operation and automatically shut-off.

ES mode *without* auto-fill: Fill the solution tank to the FULL line.

ES mode *without* auto-fill: Fill the recovery tank half full of water (to the top of the ES filter).

NOTE: If you DO NOT want to use the ES system, DO NOT put water in the recovery tank. Turn the ES switch OFF.

7. Close the tank cover.

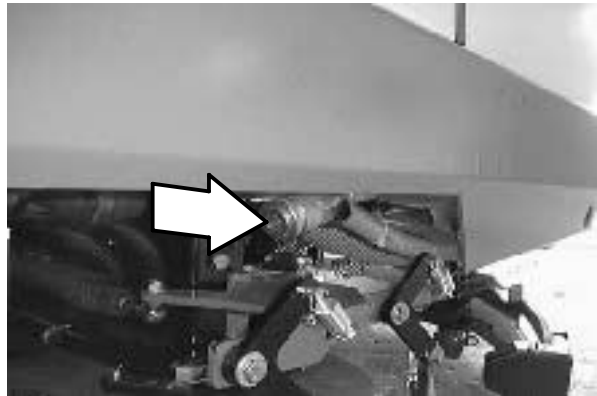

OPERATION

SCRUBBING

1. Start the engine.

FOR SAFETY: When starting machine, keep foot on brake and directional pedal in neutral.

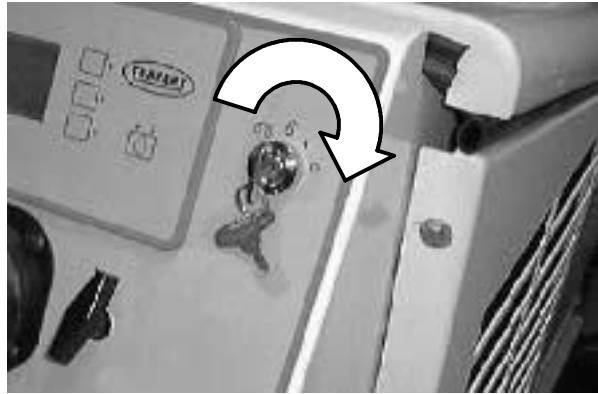

2. Adjust the solution flow to the floor as needed.

Low (1): Press the top of the switch. Use this flow rate for smooth floors and light dirt.

Off (0): Press the middle of the switch.

High (2): Press the bottom of the switch. Use this flow rate for rough floors and heavy or compacted dirt.



3. Press the scrub switch to start the scrubbing operations.

NOTE: The scrub head will raise when the directional pedal is in the neutral position. The rear squeegee will raise when the directional pedal is in the reverse position.

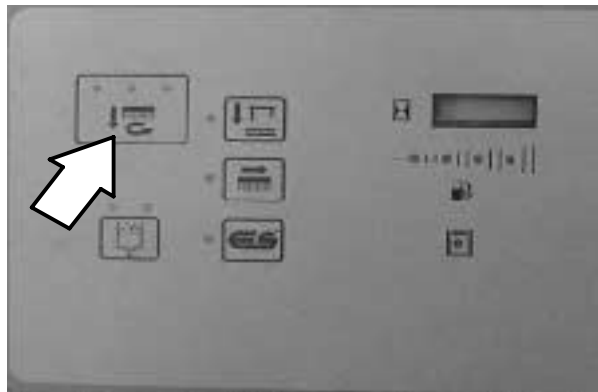

- Adjust brush pressure for cleaning application.

Scrub brush pressure: Press and hold the scrub switch. The brush pressure will scroll through three settings. The pressure setting selected when the switch is released will be the new default brush pressure setting.

The brush pressure can be set into three different positions. Under normal conditions, the brush pressure should be set in the minimum settings (one or two indicators above switch are lit). Under heavy grime conditions, the brush pressure should be set in the maximum setting (three indicators lit). Travel speed and floor conditions will affect the scrubbing performance.

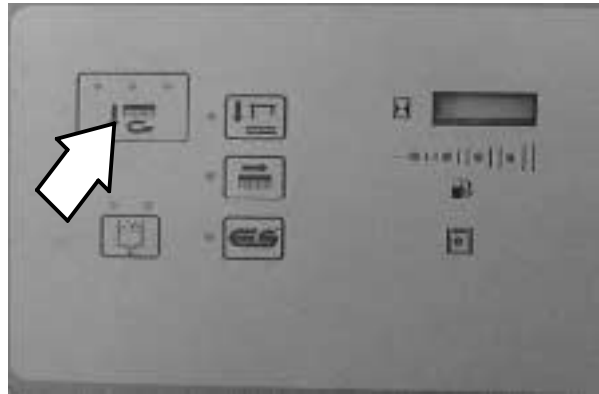

- Press the edge scrub switch (option) if edge scrubbing is necessary.

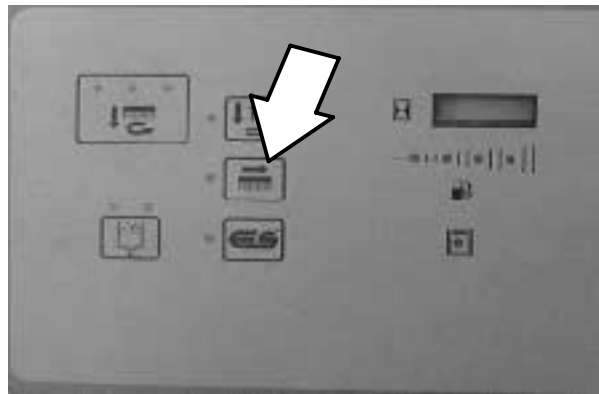

- Press the ES switch (option) if extended scrubbing is necessary.

NOTE: When using the ES (option), the recovery tank must be filled with water up to the top of the ES filter.

*NOTE: If you **do not** want to use the ES system, press the ES switch so the indicator next to the switch is off.*

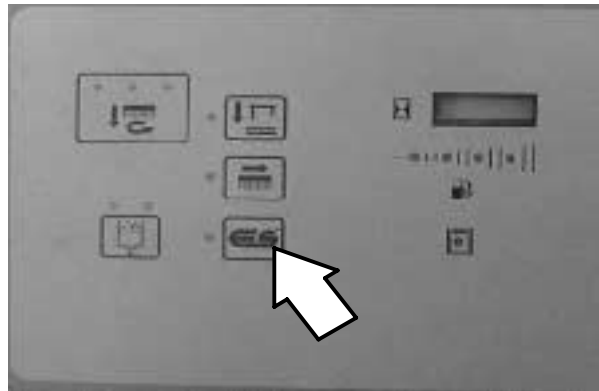

- Drive the machine forward and scrub as required.



WARNING: Flammable materials or reactive metals can cause explosion or fire. Do not pick up.

OPERATION

DOUBLE SCRUBBING

Double scrubbing is the process of making two or more passes over a heavily soiled area. The first pass is made with the rear squeegee raised to allow the solution to soak into the floor.

Use the maximum solution and detergent flow settings. Use a higher brush pressure setting. Let the solution remain on the floor for 5 to 15 minutes, then make a second scrubbing pass with the rear squeegee down.

FOR SAFETY: When using machine, go slow on inclines and slippery surfaces.

STOP SCRUBBING

Press the scrub switch to stop the scrubbing operations.

The scrub brushes will stop and the scrub head will raise. The ES detergent pump (option) will stop, and the solution flow will stop. After a short delay, the rear squeegee will automatically raise and the scrubbing vacuum fan will stop. The engine speed will remain in the *fast* speed.

Continue driving the machine forward until the vacuum fan shuts off.

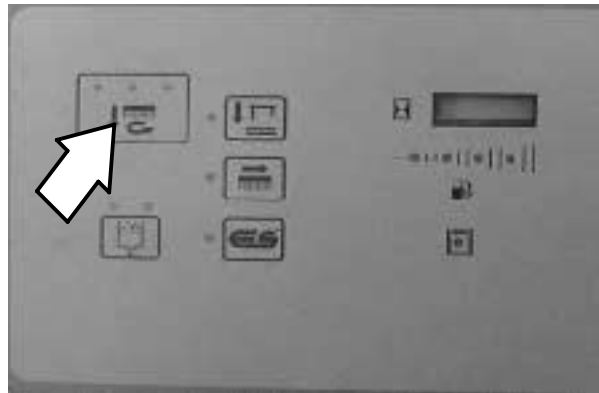

DRAINING AND CLEANING THE TANKS

When you are finished scrubbing or you hear the vacuum fan shut off and the machine starts trailing water, the recovery tank should be drained and cleaned. The solution tank then can be filled again for additional scrubbing.

If you used the machine in ES mode, the solution tank should also be drained and cleaned when you are finished scrubbing.

1. Stop scrubbing.
2. Drive the machine next to an appropriate disposal site.
3. Shut the engine off.

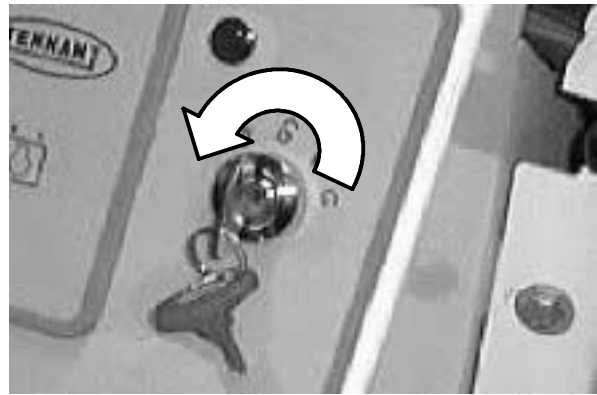

4. Set the parking brake.

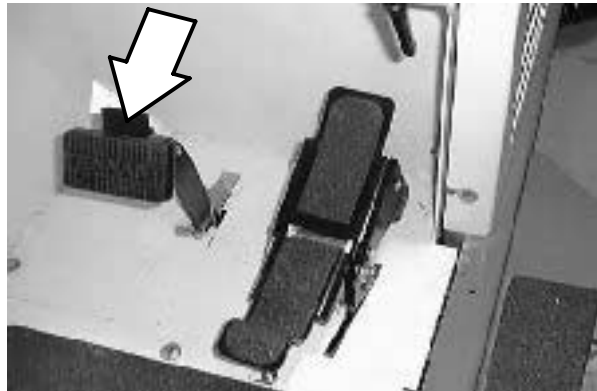

OPERATION

5. Unscrew the drain hose cap from the access cap of the recovery tank drain.
6. Pull out and place the drain hose next to the floor drain. Remove the drain end cap from the hose. Stand back, the solution rushes out of the drain hoses.



7. Open the recovery tank cover.
8. Spray the inside of the recovery tank with clean water. DO NOT allow any water to enter the vacuum fan air intake tube at the top of the tank.



9. Remove the large drain cap and flush out the bottom on the recovery tank.



10. ES mode: Lift up the ES filter by the handle until the mesh is exposed and rinse it thoroughly.

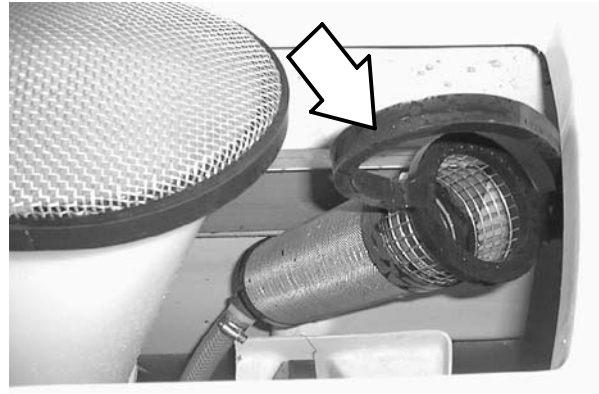

11. ES mode: Drain the solution tank. Flush out the solution tank with clean water. Rinse the solution outlet filters at the bottom of the tank through the drain access.

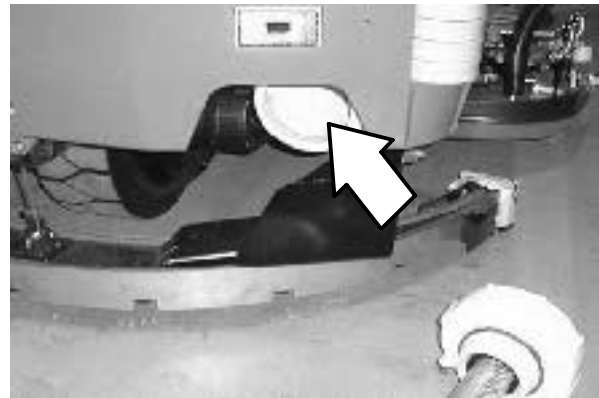

12. ES mode: Replace the recovery tank drain cap and fill the recovery tank with clean water up to the top of the ES filter.

13. ES mode: Start the ES system. Flush the ES pump by raising the float inside the recovery tank for 30 to 60 seconds.



14. Lower the recovery tank cover.
15. Shut the engine off.
16. Drain the recovery tank.
17. Replace the drain hoses and drain caps.

OPERATION

STOP THE MACHINE

1. Stop sweeping and scrubbing.
2. Take your foot off the directional pedal. Step on the brake pedal.

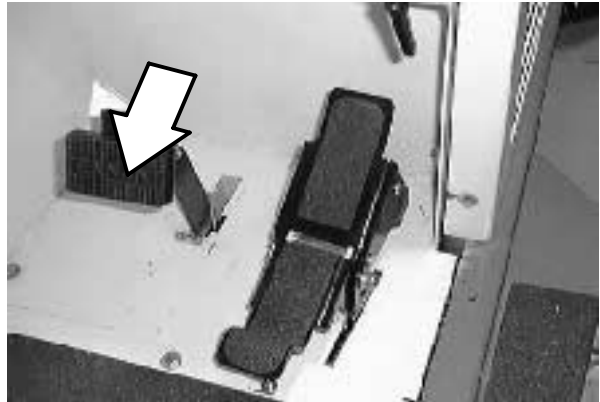

3. Shut the engine off. Remove the switch key.

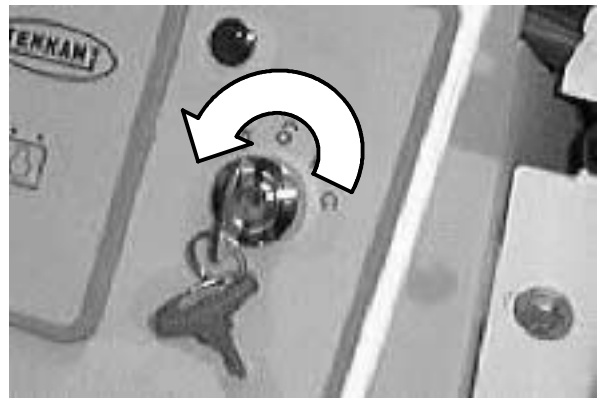

4. Set the machine parking brake.

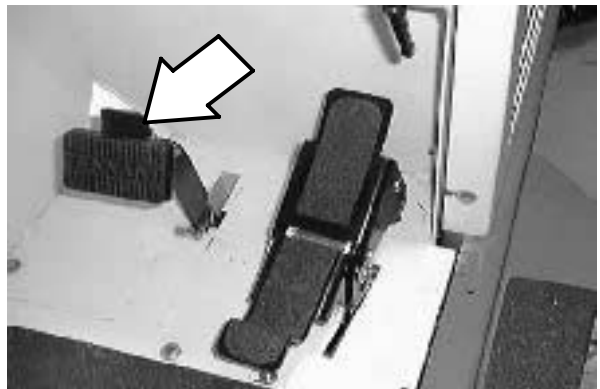

POST-OPERATION CHECKLIST

- Check the engine oil level.
- Check the engine coolant level.
- Check the radiator and hydraulic cooler fins for debris.
- Check the hydraulic fluid level
- Check the air filter indicator.
- Check the skirts and seals for damage and wear.
- Check the condition of the sweeping and scrubbing brushes. Remove any string, banding, plastic wrap, or other debris wrapped around them.
- Check the sweeping brush patterns for adjustment.
- Check the condition of the hopper dust filter and seals. Clean as required.
- Check the tank cover seals for damage and wear.
- Clean the vacuum fan inlet filter.
- Check the squeegees for damage, wear and for deflection adjustment.
- Check the vacuum hose for debris or blockage.
- ES machines; check the detergent tank level.
- Drain and clean the recovery tank.
- ES machines; drain and clean the solution tank and ES filter. Rinse level sensors.
- Check the brakes and steering for proper operation.
- Check the fuel level
- Empty the debris hopper.
- Check the service records to determine maintenance requirements.

OPERATION

ENGAGING HOPPER SUPPORT BAR

1. Set the machine parking brake.

FOR SAFETY: When starting machine, keep foot on brake and directional pedal in neutral.

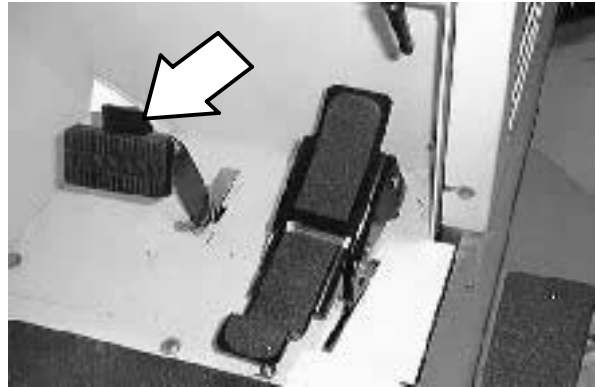

2. Start the engine.

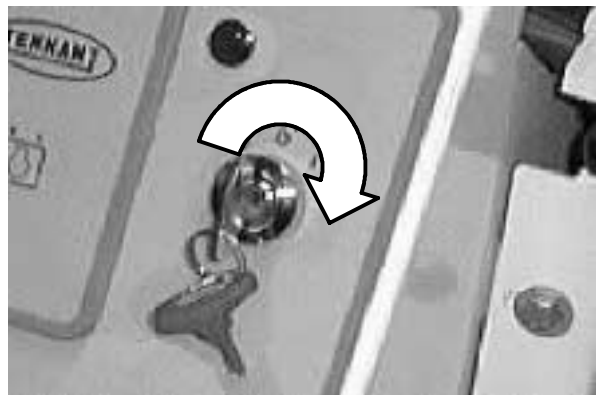

3. Pull the hopper lever backward until the hopper reaches its maximum height.

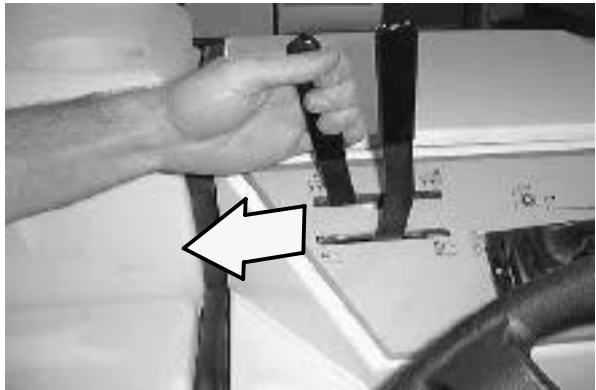

4. Lower and position the hopper support bar onto the support bar stop.

 **WARNING: Raised hopper may fall. Engage hopper support bar.**

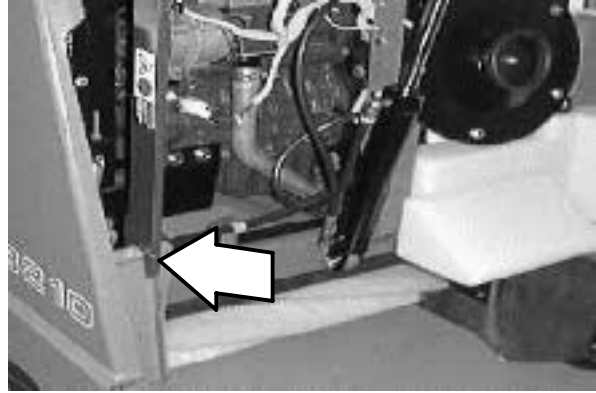

5. Slowly lower the hopper so the hopper support bar rests against the bar stop.

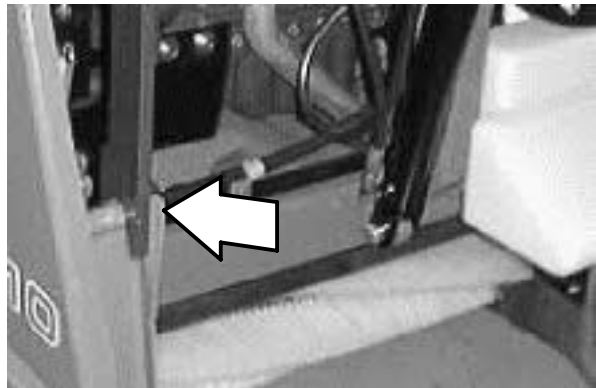
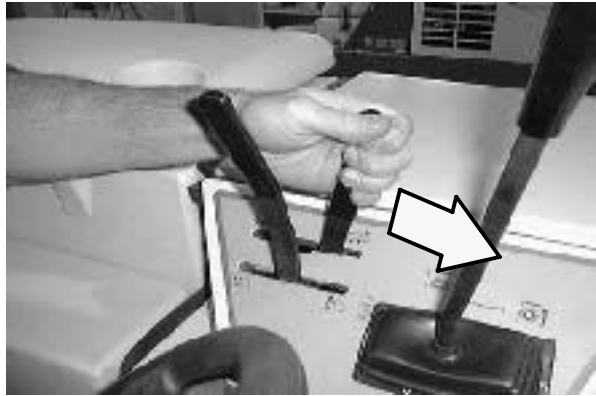

6. Shut the engine off.

OPERATION

DISENGAGING HOPPER SUPPORT BAR

1. Start the engine.

FOR SAFETY: When starting machine, keep foot on brake and directional pedal in neutral.

2. Pull the hopper lever backward to slightly raise the hopper in order to release the hopper support bar.

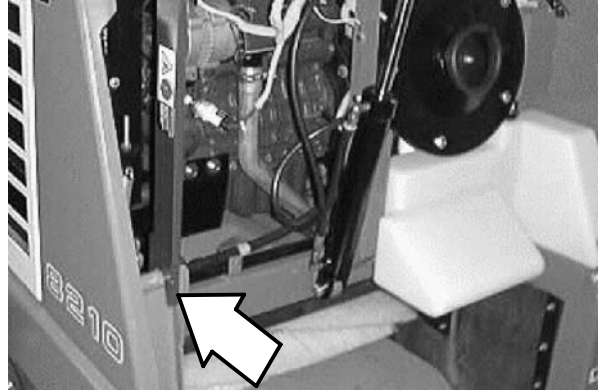

3. Put the support bar in its storage position.

⚠ WARNING: Lift arm pinch point. Stay clear of hopper lift arms.



4. Lower the hopper.
5. Shut the engine off.

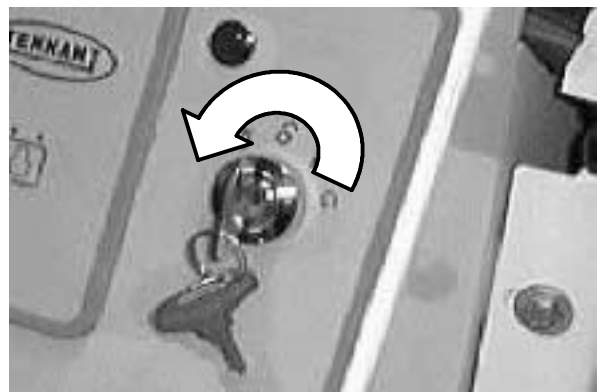

OPERATION ON INCLINES

Drive the machine slowly on inclines. Use the brake pedal to control machine speed on descending inclines. DO NOT turn the machine on an incline; drive straight up or down.

The maximum rated incline for sweeping and scrubbing with the machine is 6°. The maximum rated incline during transport of the machine is 8°.

FOR SAFETY: When using machine, go slow on inclines and slippery surfaces.

TIE DOWNS

The machine can be tied down for transport using the tie-down holes at the front and rear of the machine.

The front tie-down holes are located in front of the front tires.

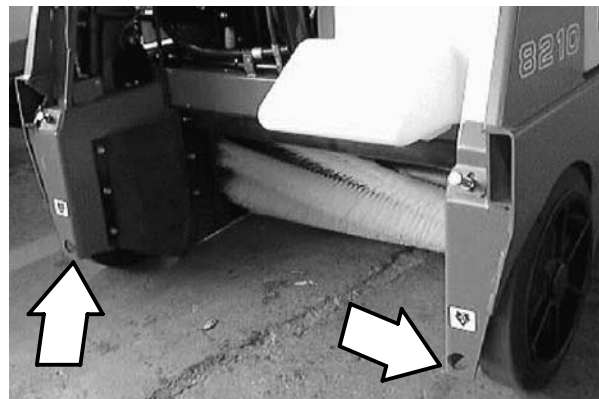

The rear tie-downs are located on the rear corners of the machine.

When transporting the machine on a trailer or in a truck, be sure to set the parking brake and block the tires to prevent the machine from rolling.

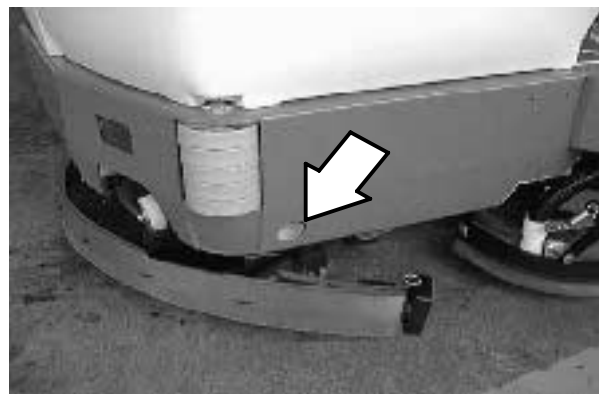

OPERATION

MACHINE TROUBLESHOOTING

Problem	Cause	Remedy
Excessive dusting	Brush skirts and dust seals worn, damaged, out of adjustment	Replace or adjust brush skirts or dust seals
	Hopper dust filter clogged	Shake and/or clean or replace dust filter
	Vacuum fan seal damaged	Replace vacuum seal
	Vacuum fan failure	Call TENNANT service personnel
	Thermo Sentry tripped	Allow Thermo Sentry to cool
	Hopper dump door closed	Open hopper dump door
Poor sweeping performance	Brush bristles worn	Replace brushes
	Main and side brushes not adjusted properly	Adjust main and side brushes
	Debris caught in main brush drive mechanism	Free drive mechanism of debris
	Main brush drive failure	Call TENNANT service personnel
	Side brush drive failure	Call TENNANT service personnel
	Hopper full	Empty hopper
	Hopper lip skirts worn or damaged	Replace lip skirts
	Wrong sweeping brush	Call TENNANT representative
	Hopper dump door closed	Open hopper dump door
Trailing water – poor or no water pickup.	Worn rear squeegee blades.	Rotate or replace blades
	Rear squeegee out of adjustment	Adjust rear squeegee
	Worn side squeegee blades.	Replace side squeegee blades
	Side squeegees out of adjustment	Adjust side squeegees
	Recovery tank cover not seated	Reseat tank cover
	Recovery tank cover seal worn	Replace seal
	Too much solution flow to floor	Reduce solution flow to floor
	Vacuum hose clogged	Flush vacuum hoses
	Rear squeegee tube clogged	Flush squeegee tube
	Recovery tank full	Drain recovery tank
		Check ES pump and filter
	Float stuck shutting off vacuum	Clean float
	Debris caught on rear squeegee	Remove debris
	Foam filling recovery tank	Empty recovery tank; use less or change detergent
	Vacuum hose to rear squeegee disconnected	Reconnect
	Vacuum-fan-to-recovery-tank-hose damaged	Replace hose
	Too much solution flow for floor conditions / machine speed	Adjust manual flow control valve to reduce total solution flow

Problem	Cause	Remedy
Little or no solution flow to the floor.	Solution tank empty.	Fill solution tank.
	Solution flow switch turned off.	Turn solution flow switch on.
	Solution supply lines plugged.	Flush solution supply lines.
	ES switch off.	Turn ES switch on.
	Manual control valve nearly closed	Open valve more
Poor scrubbing performance.	Debris caught on scrub brushes.	Remove debris.
	Improper detergent or brushes used.	Check with TENNANT representative for advice.
	Worn scrub brushes.	Replace scrub brushes.
ES system does not fill solution tank.	Clogged solution pump or lines.	Flush ES system.
	ES float stuck.	Clean floats of debris.
	Clogged ES pump filter.	Clean filter.
	Water levels too low in tanks.	Add water.

MAINTENANCE

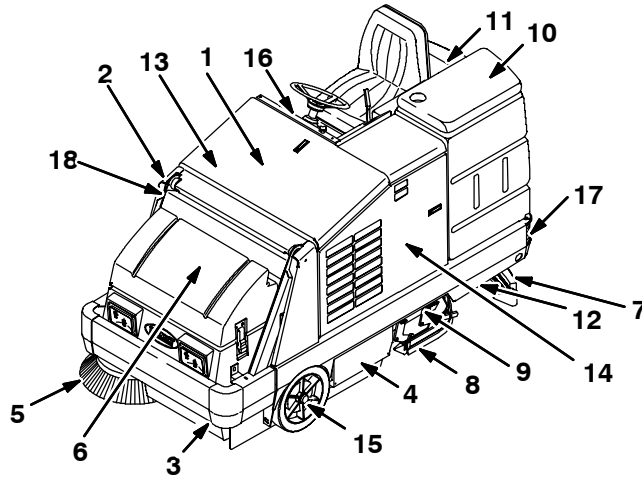

351551

MAINTENANCE CHART

NOTE: Check procedures indicted (■) after the first 50-hours of operation.

Interval	Key	Description	Procedure	Lubricant/ Fluid	No. of Service Points
Daily	1	Engine air filter	Check indicator	-	1
			Empty dust cap	-	1
			Clean / change filter element as necessary	-	1
	1	Engine crankcase	Check oil level	EO	1
	2	Brush compartment skirts	Check for damage, wear and adjustment	-	5
	3	Hopper lip skirts	Check for damage, wear and adjustment	-	3
	4	Main sweep brush	Check for damage, wear, and adjustment	-	1
			Check brush pattern	-	1
	5	Side brush	Check for damage, wear, and adjustment	-	1
			Check brush pattern	-	1
	6	Hopper dust filter	Shake to clean	-	2
	7	Rear Squeegee	Check for damage and wear	-	1
			Check deflection	-	1
	8	Side Squeegees	Check for damage and wear	-	2
9	Scrub brushes	Check for damage and wear	-	1	
10	Recovery tank	Clean	-	1	
10	Recovery tank, ES mode	Clean ES filter	-	1	
11	Solution tank, ES mode	Clean	-	1	
50 Hours	1	Engine crankcase	Change oil and filter element	EO	1
	4	Main sweep brush	Rotate end-for-end	-	1
100 hours	13	Radiator	Clean core exterior	-	1
			Check coolant level	WG	1
	1	Engine belts	Check belt tension	-	1
	6	Hopper dust filter	Check for damage, clean or replace	-	1

Interval	Key	Description	Procedure	Lubricant/ Fluid	No. of Service Points
100 hours	14	Hydraulic fluid reservoir	Check fluid level	HYDO	1
	15	Tires	Check all for damage	-	3
	2,6	Main sweep brush and hopper seals	Check for damage or wear	-	8
	7	Rear squeegee	Check leveling	-	1
	10, 11	Tank cover seals	Check for damage or wear	-	2
	12	Scrub head drag link arm pivot points	Lubricate	SPL	4
200 Hours	17	Rear wheel support bearings	Lubricate	SPL	2
	13	Radiator hoses and clamps	Check for tightness and wear	-	2
	16	Parking brake	Check adjustment	-	1
	16	Brake pedal	Check travel adjustment	-	1
	18	Hopper lift arm pivots	Lubricate	SPL	2
400 Hours	1	Engine	Change fuel filter	-	2
	15	Front wheel bearings	Check, lubricate, and adjust	SPL	2
	1	Valve clearance (first 400 hours of machine use)	Check / adjust valve clearance	-	2
800 hours	1	Engine	Torque intake manifold bolts	-	8
	13	Cooling system	Flush	WG	2
	14	Hydraulic fluid reservoir	Change hydraulic fluid	HYDO	1
			Replace suction strainer		1
			Replace hydraulic breather		1
			Replace cap		1
	14	Hydraulic fluid filter	Change filter element	-	1
	-	Hydraulic hoses	Check for wear and damage	-	All
	1	Propelling motor	■Torque shaft nut	-	1
	17	Rear wheel	■Torque wheel nuts	-	1
1	Battery	■Clean and tighten battery cable connections	-	1	

LUBRICANT/FLUID

EO Engine oil, diesel rating *above* CD grade only.

HYDO . . . Tennant or approved hydraulic fluid

WG Water and permanent-type ethylene glycol anti-freeze, -34° C (-30° F)

SPL Special lubricant, Lubriplate EMB grease (Tennant part number 01433-1)

NOTE: More frequent intervals may be required in extremely dusty conditions.

LUBRICATION

ENGINE

Check the engine oil level daily. Change the engine oil and oil filter every 50 hours of machine operation. Use engine oil with a diesel rating *above* CD grade.

Fill the engine with oil to the level indicated on the oil dipstick. Low oil level is indicated by the mark closest to the end of the dipstick. Full level is indicated by the mark closest to the top of the dipstick. The engine oil capacity is 6.15 L (6.5 qt) without the oil filter.

The engine oil drain hose is located on the left-hand side of the machine, in front and above the scrub brushes.

The engine oil filter is mounted on the front of the engine, behind the hopper.

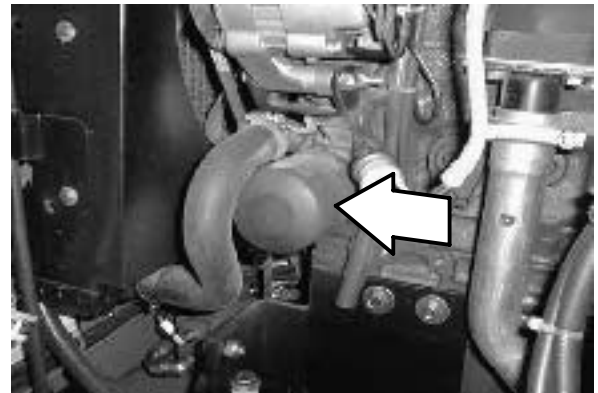
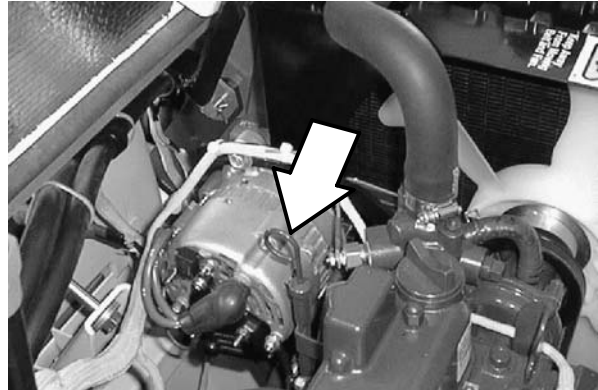

REAR WHEEL SUPPORT

The rear wheel support pivots the rear wheel. The support has two grease fittings for the bearings. The rear wheel support bearings must be lubricated every 200 hours of operation. Use Lubriplate EMB grease (Tennant part number 01433-1).



FRONT WHEEL BEARINGS

Inspect the front wheel bearings for seal damage, and repack and adjust every 400 hours of operation. Use Lubriplate EMB grease (Tennant part number 01433-1).



HOPPER LIFT ARM PIVOTS

The hopper lift arms have two grease fittings, one on each lift arm at the top pivot.

The lift arms should be lubricated every 200 hours of operation. Use Lubriplate EMB grease (Tennant part number 01433-1).

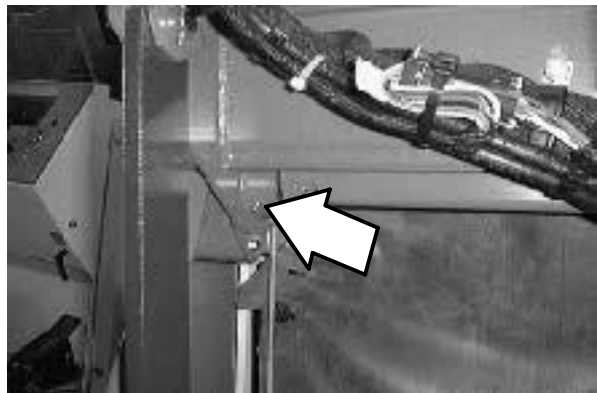

SCRUB HEAD DRAG LINK ARMS

The scrub head drag link arms of the Edge scrub and Max Pro 1200 have a grease fitting at each end of the pivot points.

The scrub head drag link arms should be lubricated every 100 hours of operation. Use Lubriplate EMB grease (Tennant part number 01433-1).

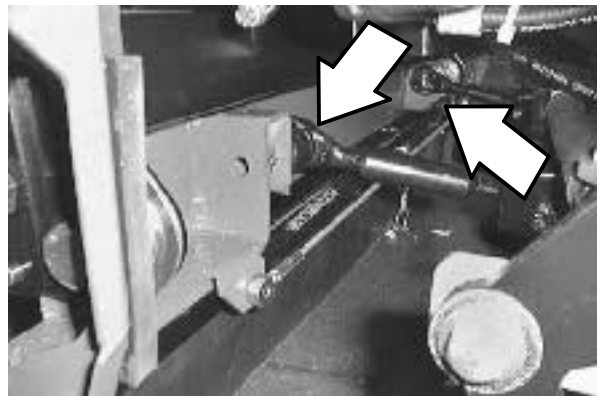

HYDRAULICS

HYDRAULIC FLUID RESERVOIR

The reservoir is located on the left side of the machine.

Mounted on top of the reservoir is a filler cap with a built-in breather and fluid level dipstick. Replace the cap every 800 hours of operation.

Check the hydraulic fluid level at operating temperature every 100 hours of operation. Make sure the hopper is down when checking hydraulic fluid level. The end of the dipstick is marked with FULL and ADD levels to indicate the level of hydraulic fluid in the reservoir.

Lubricate the filler cap gasket with a film of hydraulic fluid before putting the cap back on the reservoir.

ATTENTION! Do not overfill the hydraulic fluid reservoir or operate the machine with a low level of hydraulic fluid in the reservoir. Damage to the machine hydraulic system may result.

Drain and refill the hydraulic fluid reservoir with new hydraulic fluid every 800 hours of operation.

The hydraulic fluid filter is located at the bottom of the engine compartment. Replace the filter element every 800 hours of operation.

The reservoir has a built-in strainer outlet that filters hydraulic fluid before it enters the system. Replace the strainer every 800 hours of operation.

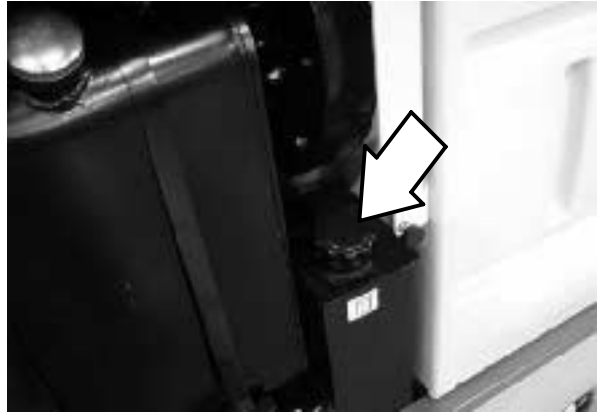

HYDRAULIC FLUID

The quality and condition of the hydraulic fluid play a very important role in how well the machine operates. Tennant’s hydraulic fluid is specially selected to meet the needs of Tennant machines.

Tennant’s hydraulic fluids provide a longer life for the hydraulic components. There are two fluids available for different temperature ranges:

Tennant part no.	Ambient Temperature
65869	above 7° C (45° F)
65870	below 7° C (45° F)

The higher temperature fluid has a higher viscosity and should not be used at the lower temperatures. Damage to the hydraulic pumps may occur because of improper lubrication.

The lower temperature fluid is a thinner fluid for colder temperatures.

If a locally-available hydraulic fluid is used, make sure the specifications match Tennant hydraulic fluid specifications. Using substitute fluids can cause premature failure of hydraulic components.

ATTENTION! Hydraulic components depend on system hydraulic fluid for internal lubrication. Malfunctions, accelerated wear, and damage will result if dirt or other contaminants enter the hydraulic system.

MAINTENANCE

HYDRAULIC HOSES

Check the hydraulic hoses every 800 hours of operation for wear or damage.

Fluid escaping at high pressure from a very small hole can be almost invisible, and can cause serious injuries.

See a doctor at once if injury results from escaping hydraulic fluid. Serious infection or reaction can develop if proper medical treatment is not given immediately.

FOR SAFETY: When servicing machine, use cardboard to locate leaking hydraulic fluid under pressure.

If you discover a fluid leak, contact your mechanic or supervisor.

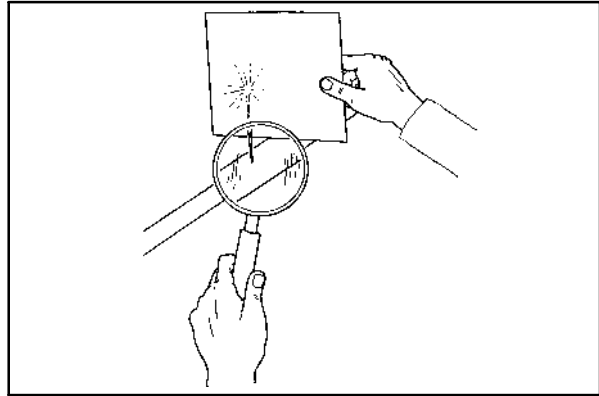

00002

PROPELLING MOTOR

Torque the shaft nut to 508 Nm (375 ft lb) lubricated, 644 Nm (475 ft lb) dry after the first 50-hours of operation, and every 800 hours there after.

ENGINE

COOLING SYSTEM

Check the radiator coolant level every 100 hours of operation. Use clean water mixed with a permanent-type, ethylene glycol antifreeze to a -34°C (-30°F) rating.

FOR SAFETY: When servicing machine, avoid contact with hot engine coolant.

Check the radiator hoses and clamps every 200 hours of operation. Tighten the clamps if they are loose. Replace the hoses and clamps if the hoses are cracked, harden, or swollen.

Check the radiator core exterior and hydraulic cooler fins for debris every 100 hours of operation. Blow or rinse all dust, which may have collected on the radiator, in through the grille and radiator fins, opposite the direction of normal air flow. Be careful not to bend the cooling fins when cleaning. Clean thoroughly to prevent the fins becoming encrusted with dust. Clean the radiator and cooler only after the radiator has cooled to avoid cracking.

FOR SAFETY: When servicing machine, wear eye and ear protection when using pressurized air or water.

Flush the radiator and the cooling system every 800 hours of operation, using a dependable cleaning compound.

AIR FILTER INDICATOR (OPTIONAL)

The air filter indicator shows when to replace the air filter element. Check the indicator daily. The indicator's red line will move as the air filter element fills with dirt. Do not replace the air filter element until the red line reaches 5 kPa (20 in H₂O) and the "SERVICE WHEN RED" window is filled with red. The indicator's red line may return to a lower reading on the scale when the engine shuts off. The red line will return to a correct reading after the engine runs for a while.

Reset the air filter indicator by pushing the reset button on the end of the indicator after replacing the air filter element.

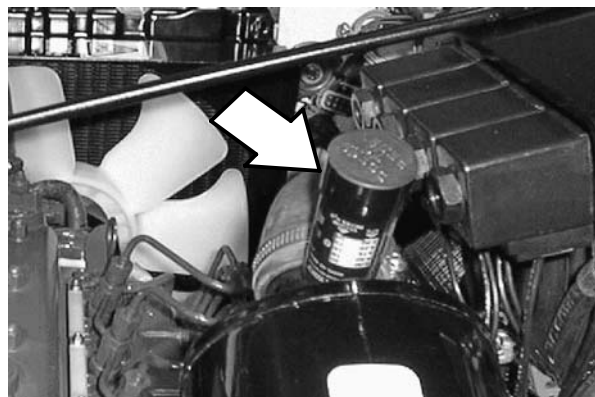
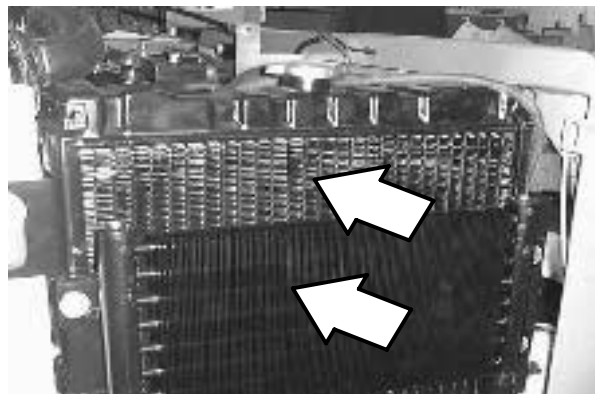
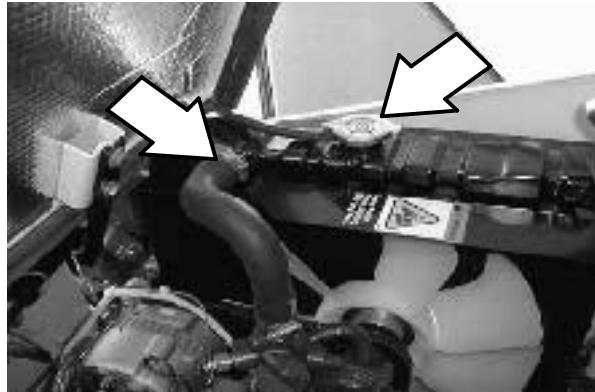

AIR FILTER

The engine air filter housing has a dust cap and a dry cartridge-type air filter element. Empty the dust cap daily. The air filter must be replaced whenever the filter element is damaged or when the optional air filter indicator shows a restriction. The air filters cannot be cleaned.

Machines with the heavy duty air filter (option) have a safety element inside the the standard element. Replace the inner element after the regular element becomes damaged or has been changed three times.

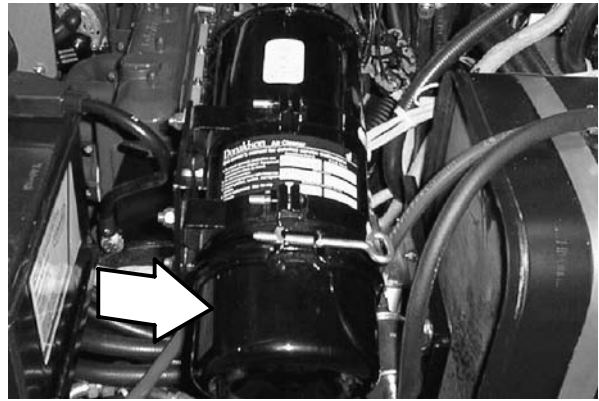

Install the dust cap on the air filter housing with the arrows pointing up.

Replace the air filter element only when the air filter indicator shows restriction in the air intake system. Do not remove the air filter element from the housing unless it is restricting air flow.

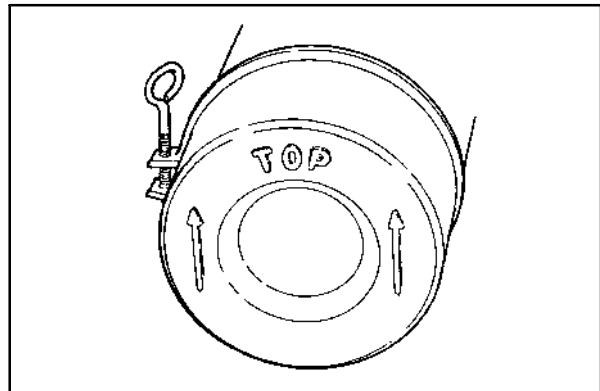

02492

FUEL FILTER

The fuel filter cartridge filters impurities from the fuel. The filter is located by the fuel tank.

Replace the fuel filter element every 400 hours of operation.

BATTERY

The battery for the machine is a low maintenance battery. Do not add water to the battery or remove the battery vent plugs.

The battery is located at the front of the engine compartment.

After the first 50 hours of operation, and every 800 hours after that, clean and tighten the battery connections.

FOR SAFETY: When servicing machine, avoid contact with battery acid.

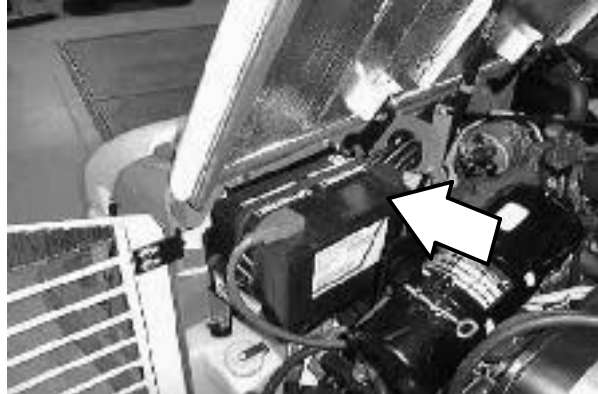

BELTS AND CHAINS

ENGINE BELT

The engine belt is driven by the engine crankshaft pulley and drives the water pump and alternator pulleys. Proper belt tension is 13 mm (0.50 in) from a force of 4 to 5 kg (8 to 10 lb) applied at the mid-point of the longest span.

Check and adjust the belt tension every 100 hours of operation.



WARNING: Moving belt and fan. Keep away.

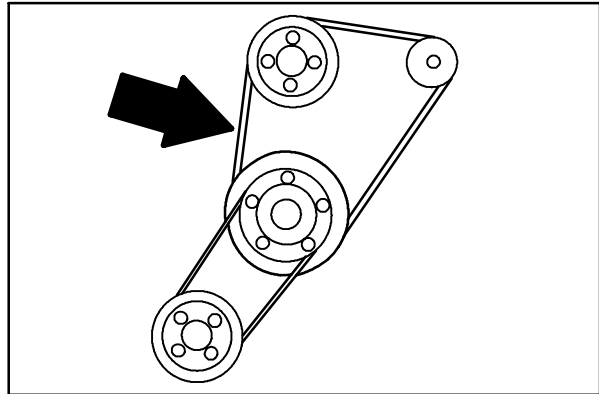

351646

ACCESSORY PUMP BELT

The accessory pump belt is driven by the engine crankshaft pulley and drives the accessory pump.



WARNING: Moving belt and fan. Keep away.

Check and adjust the belt tension every 100 hours of operation.

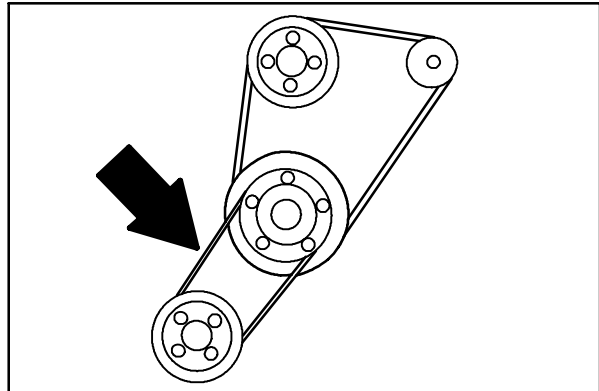

351646

Accessory pump belt adjustment is made by turning the bolt on top of the tension spring. The tension spring is located at the front of the engine compartment, near the accessory pump belt sheave. The accessory pump belt is at the proper tension when the tension spring is compressed to 3.81 cm \pm 0.0076 mm (1.5 in \pm 0.030 in). When adjusting the accessory pump belt tension, measure only the spring and not the washers at either end.

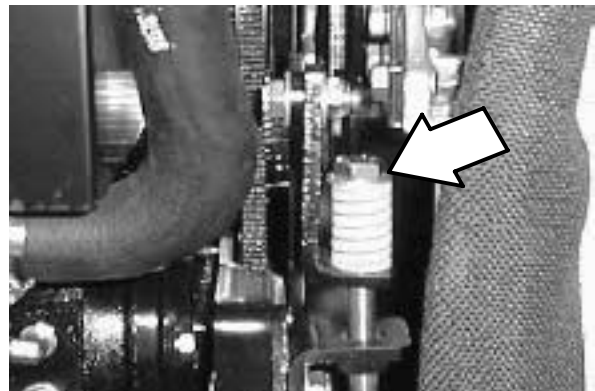

STATIC DRAG CHAIN

The static drag chain prevents the buildup of static electricity in the machine. The chain is attached to the machine directly in front of the scrub head and brushes.

Make sure the chain is touching the floor at all times.

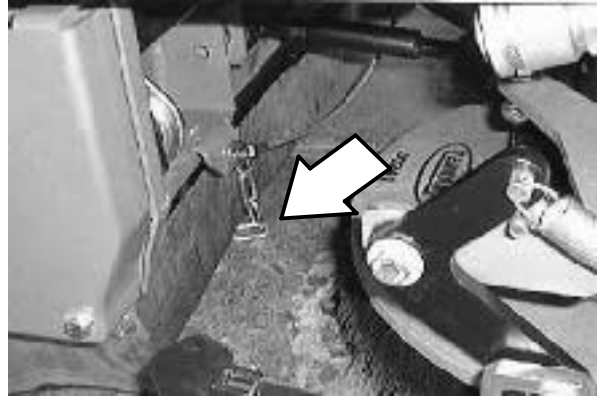

DEBRIS HOPPER

HOPPER DUST FILTER

The dust filter filters the air pulled up from the hopper. The dust filter is equipped with a shaker to remove the accumulated dust particles. The dust filter shaker is operated by the filter shaker switch.

The standard dust filter works well for normal sweeping applications. The synthetic filter works well for humid or wet applications.

Shake the dust filter before emptying the hopper and at the end of every work shift. Check and clean or replace the dust filter every 100 hours of operation.

To clean the dust filter, use one of the following methods:

- **SHAKING** - Press the filter shaker switch.
- **TAPPING** - Tap the filter gently on a flat surface with the dirty side down. Do not damage the edges of the filter element or the filter will not seat properly in the filter frame.
- **AIR** - Always wear eye protection when using compressed air. Blow air through the dust filter opposite the direction of the arrows. Never use more than 690 kPa (100 psi) of air pressure and never closer than 50 mm (2 in) away from the filter. This may be done with the dust filter in the machine.

FOR SAFETY: When servicing machine, wear eye and ear protection when using pressurized air or water.

- **WATER** - Rinse the synthetic filter with a low pressure garden hose through the dust filter opposite the direction of the arrows. The standard dust filter can also be rinsed, but the filter will degrade with each rinsing and should be replaced after rinsing five times.

NOTE: Be sure the dust filter is dry before reinstalling it in the machine.



REMOVING HOPPER DUST FILTER

1. Stop the engine and set the machine parking brake.

FOR SAFETY: Before leaving or servicing machine; stop on level surface, set parking brake, turn off machine and remove key.

2. Open the hopper cover.
3. Lift the dust filter element out of the hopper insert.



4. Clean or discard the dust filter as required.
5. Put the cleaned or new dust filter in the hopper insert with the arrows pointing up.
6. Close the hopper cover.



THERMO SENTRY

The Thermo Sentry, located inside the hopper, senses the temperature of the air pulled up from the hopper. If there is a fire in the hopper, the Thermo Sentry stops the vacuum fan and cuts off the air flow.

The Thermo Sentry resets itself automatically after cooling down.

SCRUB HEAD

The scrub head encloses the scrub brushes and a solution dispensing system. The scrub head is located directly behind the sweeping brush compartment.

The scrub head is factory adjusted and the measurement should not be changed unless scrub head parts are damaged or are replaced.

BRUSHES

MAIN SWEEP BRUSH

The main sweep brush is cylindrical and spans the width of the machine, sweeping debris into the hopper.

Check the brush daily for wear or damage. Remove any string or wire tangled on the main brush, main brush drive hub, or main brush idler hub.

Check the main sweep brush pattern daily. The pattern should be 50 to 65 mm (2.0 to 3.0 in) wide with the main sweep brush in the lowered position. Adjust the main sweep brush pattern by turning the main brush pressure knob located to the left of the steering wheel, at the top of the instrument panel.

Rotate the main brush end-for-end every 50 hours of operation for maximum brush life and best sweeping performance.

Sweeping performance often becomes less effective as the bristle length is worn. Replace the main sweep brush when the remaining bristles measure between 40 mm (1¹/₂in) and 50 mm (2 in) in length.



REPLACING MAIN SWEEP BRUSH

1. Stop the engine and set the machine parking brake.

FOR SAFETY: Before leaving or servicing machine; stop on level surface, set parking brake, turn off machine and remove key.

2. Release the scrub head guard arm by pulling the retaining clip over the top of the pin. Remove the pin. Swing the scrub head guard arm out toward the front tire.

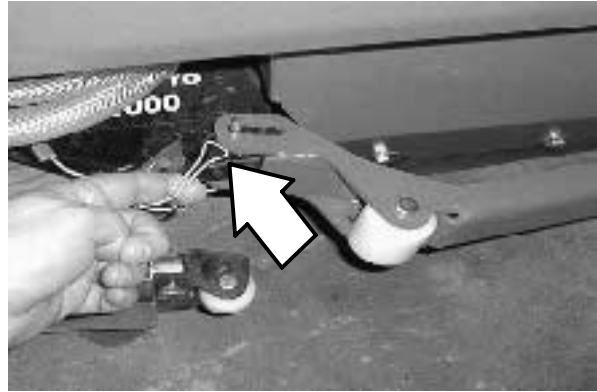

3. Unlatch and swing the right side main brush door open. The latch is located just to the rear of the door and must be pushed upward to release the door.

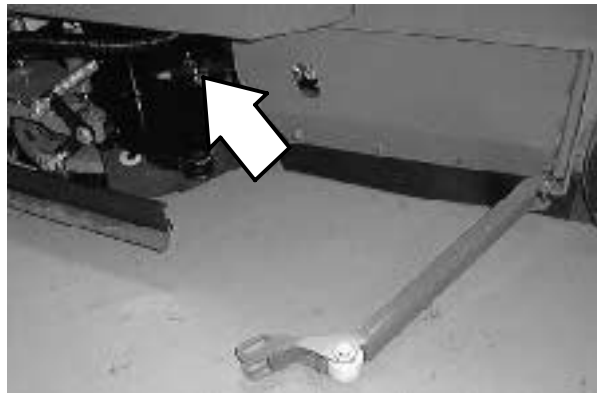

4. Remove the main brush idler plate by turning the idler plate retainer nut counter-clockwise.

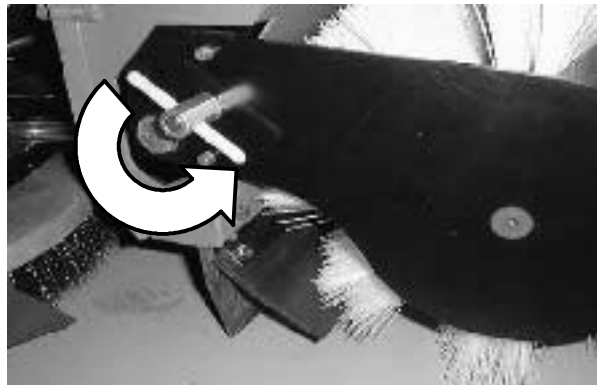

MAINTENANCE

5. Pull the main sweep brush off the brush drive plug and out of the main brush compartment.
6. Rotate the main brush end for end or, if necessary, install a new main brush.
7. Slide the main sweep brush onto the drive plug. Rotate the brush until it engages the drive plug. Push it all the way onto the plug.

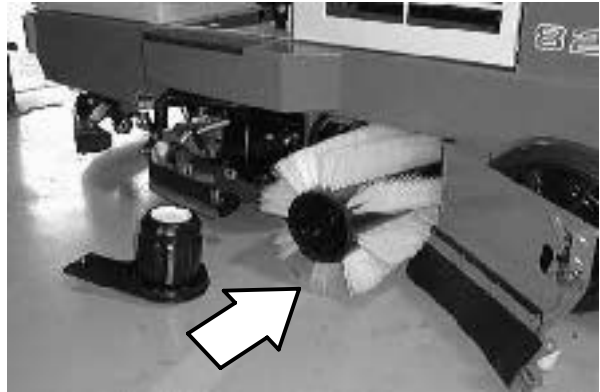

8. Replace the main brush idler plate and secure it by turning the idler plate retainer nut clockwise.

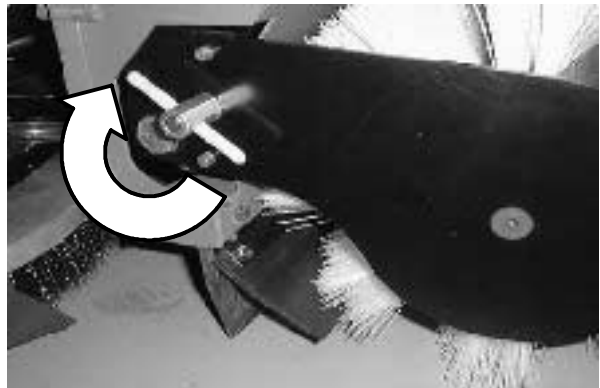

9. Close and latch the main brush door, then swing the scrub head guard arm back in place and replace the pin. Install the pin from the bottom up.

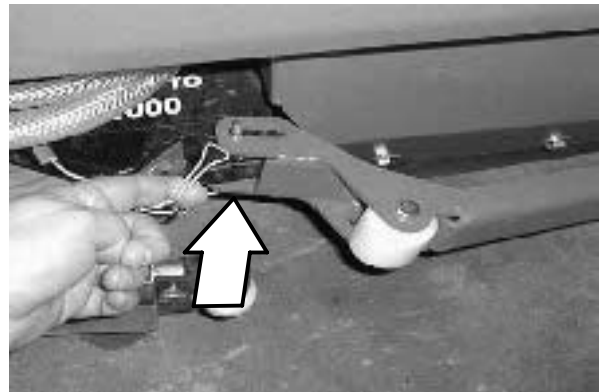

CHECKING AND ADJUSTING MAIN SWEEP BRUSH PATTERN

1. Apply chalk, or some other material that will not easily blow away to a smooth and level section of the floor.

NOTE: If chalk or other material is not available, in Step 4 allow the sweep brush to spin on the floor for two minutes. A polish mark will remain on the floor.

2. Position the main sweep brush over the chalked area.
3. Start the main sweep brush.
4. Allow the main brush to sweep for 15 to 20 seconds while keeping a foot on the brakes to keep the machine from moving.

NOTE: If chalk or other material is not available, allow the sweep brush to spin on the floor for two minutes. A polish mark will remain on the floor.

5. Stop the main sweep brush.
6. Drive the machine off the test area.
7. Observe the width of the brush pattern. The proper brush pattern width is 50 to 65 mm (2.0 to 3.0 in).

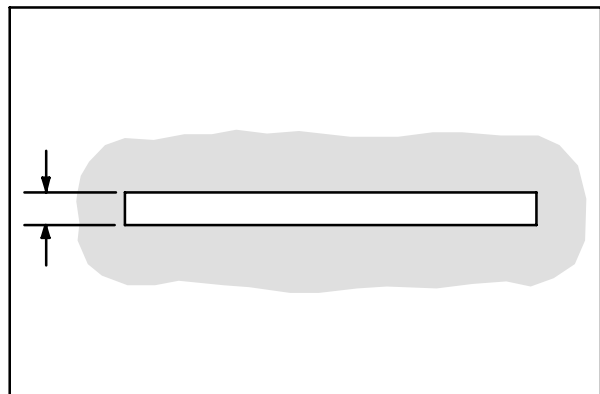

00582

MAINTENANCE

8. To increase the width of the main sweep brush pattern, turn the main sweep brush down pressure knob counter-clockwise.

To decrease the width of the main sweep brush pattern, turn the main sweep brush down pressure knob clockwise.

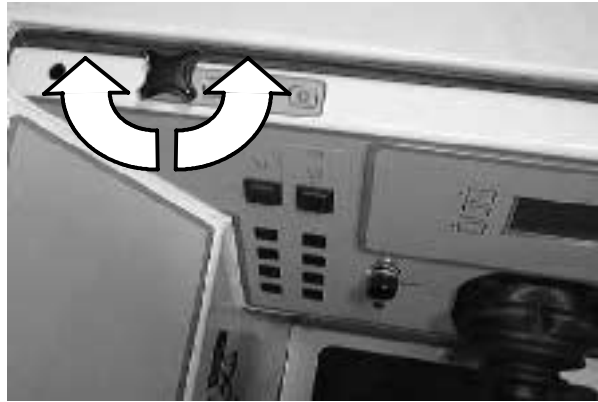

If the main sweep brush pattern is tapered more than 15 mm (0.5 in) on one end than the other, adjustment of the main brush pattern is necessary.

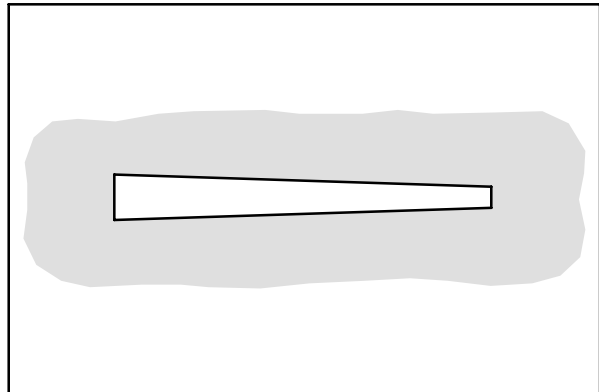

00601

- A. The bearing bracket mounting bolts (3), adjust the main brush pattern. The bolts are located behind the main brush, on the inside of the main brush idler arm. Removal of the idler arm and main brush is NOT necessary to adjust the main brush pattern.

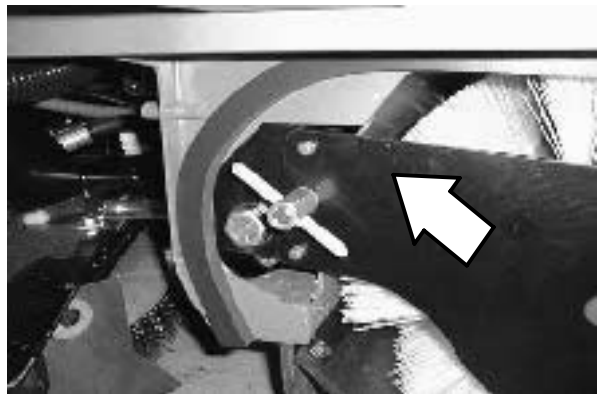

- B. Loosen the bolts (shown with idler arm and main brush removed). Move the bearing bracket down to increase the width of the brush pattern on the right-hand side or up to decrease the width of the brush pattern on the right-hand side. Tighten the bolts.



- C. Check the main sweep brush pattern and readjust as necessary.

SIDE BRUSH

The side brush sweeps debris along edges into the path of the main brush.

Check the brush daily for wear or damage. Remove any string or wire found tangled on the side brush or side brush drive hub.

Check the side brush pattern daily. The side brush bristles should contact the floor in a 10 o'clock to 3 o'clock pattern when the brush is in motion.

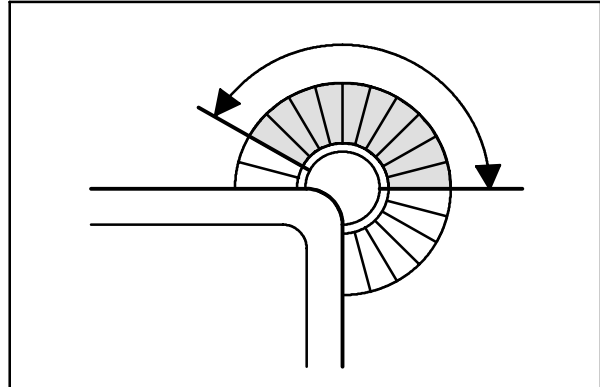

350327

Adjust the side brush pattern using the side brush down pressure knob. Turn the knob counter-clockwise to increase the brush contact with the sweeping surface, and clockwise to decrease the brush contact with the sweeping surface.



REPLACING SIDE BRUSH

The side brush should be replaced when it no longer sweeps effectively for your application. A guideline length is when the remaining bristles measure 50 mm (2 in) in length. You may change the side brush sooner if you are sweeping light litter, or wear the bristles shorter if you are sweeping heavy debris.

1. Empty the debris hopper.
2. Raise the hopper and engage the hopper support bar.

⚠ WARNING: Raised hopper may fall. Engage hopper support bar.

3. Set the machine parking brake.
4. Stop the engine.

FOR SAFETY: Before leaving or servicing machine; stop on level surface, set parking brake, turn off machine and remove key.

5. Remove the side brush retaining pin from the side brush drive shaft by pulling the pin keeper off the end of the pin.
6. Slide the side brush off the side brush drive shaft.

NOTE: Remove the drive hub and put it on the new brush if one is not installed.

7. Slide the new side brush onto the side brush drive shaft.
8. Insert the side brush retaining pin through the side brush hub and shaft.
9. Secure the pin by clipping the pin keeper over the end of the pin.
10. Disengage the hopper support bar and lower the hopper.
11. Adjust the side brush pattern with the side brush down pressure knob.

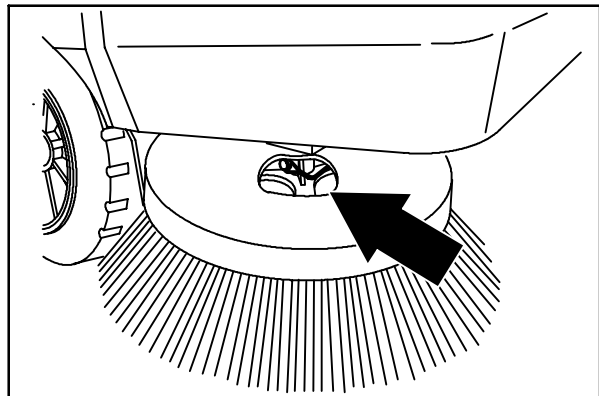

08019

SCRUB BRUSHES

Two disc-type scrub brushes scrub the floor. Optional three brush scrub heads are available. A spring lock clip holds the scrub brushes onto the drive hubs.

The scrub brushes should be checked daily for tangled wire or string, wear, and damage. The brushes should be replaced if large portions of the brush bristles are missing or if the remaining brush bristle measure 0.50 in (12 mm) or less in length.

NOTE: Replace all scrub brushes at the same time to ensure equal scrubbing performance.

To use the stripping, scrubbing, buffing, or polishing pads, install the pads onto brush drivers. Secure each pad onto the driver with a pad retaining plug. Install the brush drivers in place of the normal scrubbing brushes. Use the normal amount of detergent and water.

MAINTENANCE

REPLACING THE SCRUB BRUSHES

1. Stop the engine.
2. Set the machine parking brake.

FOR SAFETY: Before leaving or servicing machine; stop on level surface, set parking brake, turn off machine and remove key.

3. Press the brush spring clip ends together with your thumb and index finger to remove the scrub brush. Repeat for the other brushes.
4. When replacing scrub brushes, start with the center brush, if applicable. Slide the new scrub brush under the scrub brush drive assembly.
5. Line up the scrub brush drive socket with the drive plug.
6. Press the brush spring clip together and lift the scrub brush onto the drive plug. Release the spring clip when the brush is in place. Repeat for the other brushes.

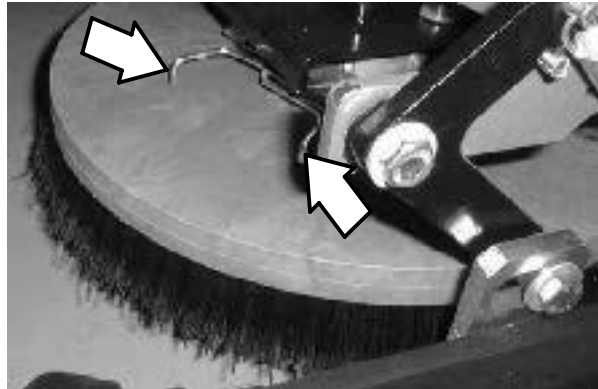

SOLUTION SYSTEM

RECOVERY TANK

Recovered solution collects in the recovery tank. The recovery tank should be drained and cleaned daily, or when the recovery tank full light comes on.

ES option: The ES filter inside the tank should be cleaned daily.

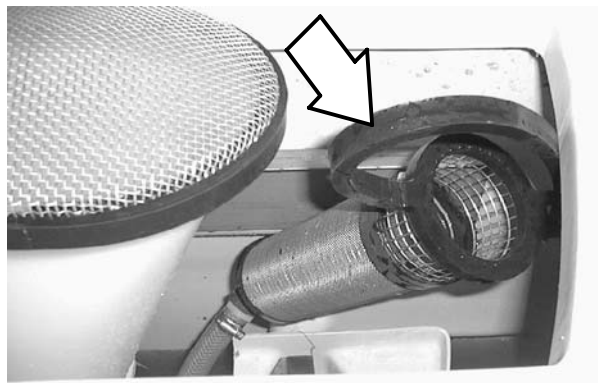

The vacuum fan air intake screen should be checked daily and cleaned as necessary. To clean the screen, remove it and spray it off with a hose. DO NOT allow any water to enter the vacuum fan air intake tube.



SOLUTION TANK

The solution tank contains the cleaning solution.

The solution tank does not require regular maintenance. If deposits form on the bottom of the tank, rinse the tank with a strong blast of warm water. The tank can be flushed through the drain opening. Drain the tank with the solution tank drain hose.

The solution tank on machines with the ES option should be drained and cleaned daily. Rinse the solution outlet filters at the bottom of the tank through the drain access.



SQUEEGEES

The rear squeegee channels water into the vacuum fan suction. The front blade channels the water, and the rear blade wipes the floor.

The side squeegees control water spray and channel water into the path of the rear squeegee.

REAR SQUEEGEE

Check the squeegee blades for damage and wear daily. Rotate or replace either of the squeegee blades if the leading edge is torn or worn half-way through the thickness of the blade.

The squeegee can be adjusted for leveling and deflection. The deflection of the squeegee blades should be checked daily, or when scrubbing a different type of floor. The leveling of the squeegee should be checked every 100 hours of machine operation.

MAINTENANCE

LEVELING THE REAR SQUEEGEE

Leveling of the squeegee assures even contact the length of the squeegee blade with the surface being scrubbed. Make sure this adjustment is done on an smooth, level floor.

1. Lower the rear squeegee. Shut off the engine and set the machine parking brake.

FOR SAFETY: Before leaving or servicing machine; stop on level surface, set parking brake, turn off machine and remove key.

2. Grab the rear squeegee assembly and lift it until the assembly is resting on the squeegee blades without any deflection.
3. Loosen the cam locking screws located on the outside of each upper squeegee linkage by turning 1/2 to 1 turn. Do NOT overturn as this may disengage the cam locking tabs.

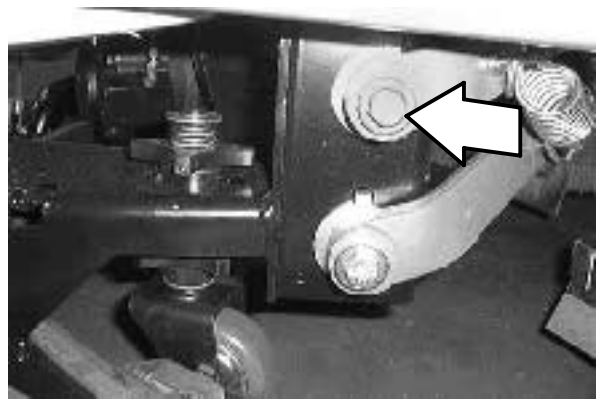

4. Adjust the squeegee blade until it deflects more at the center and less at the tips. The adjustment cams are located on the inside of the squeegee frame. Turn the adjustment cams forward to raise the tips of the squeegee and backward to lower the tips of the squeegee. The notch on the cam will be straight up or slightly toward the rear when adjusted properly. Hold the cam in this position and tighten the cam locking screws.

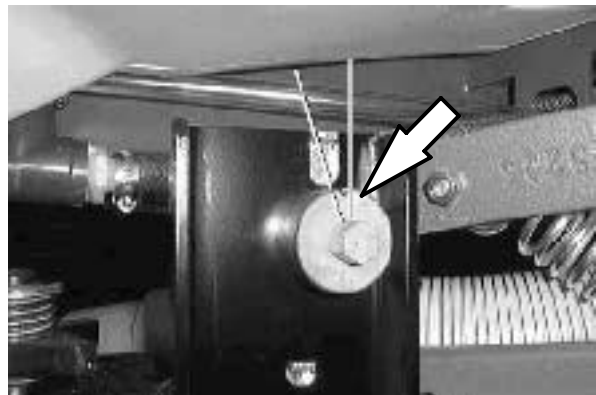

5. Start the machine, lower the squeegee and drive it forward to check the squeegee blade deflection. The squeegee blade should deflect more at the center and less at the tips. See *ADJUSTING REAR SQUEEGEE BLADE DEFLECTION* section of this manual.

ADJUSTING REAR SQUEEGEE BLADE DEFLECTION

Deflection is the amount of curl the squeegee blade has when the machine moves forward with the squeegee lowered to the floor.

1. Lower the squeegee and drive the machine forward.
2. Shut off the engine and set the machine parking brake.

FOR SAFETY: Before leaving or servicing machine; stop on level surface, set parking brake, turn off machine and remove key.

3. Look at the deflection of the rear squeegee blade. The correct amount of deflection is 25 to 22 mm (1.00 to 0.88 in) at the center of the squeegee and about 3 mm (0.12 in) less deflection at the tips of the squeegee.

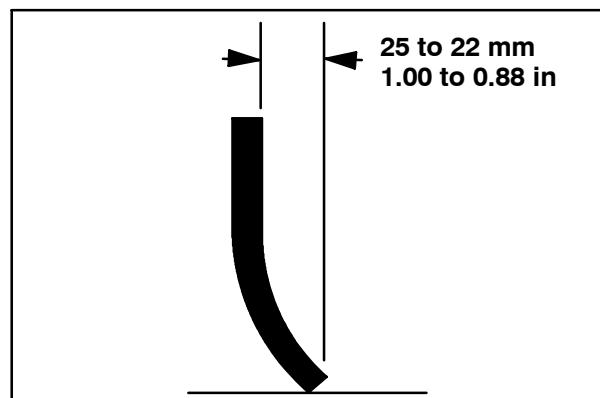

03719

4. To adjust the amount of deflection, loosen the top knob on the two casters.
5. Turn the bottom knob clockwise to decrease the blade deflection. Turn the bottom knob counter-clockwise to increase the blade deflection. Be sure to turn both knobs the **same** number of turns. Tighten the top knobs on the casters.
6. Start the machine, lower the squeegee and drive the machine forward again to check the squeegee blade deflection. Readjust the squeegee blade deflection if necessary.
7. Raise the squeegee when finished.

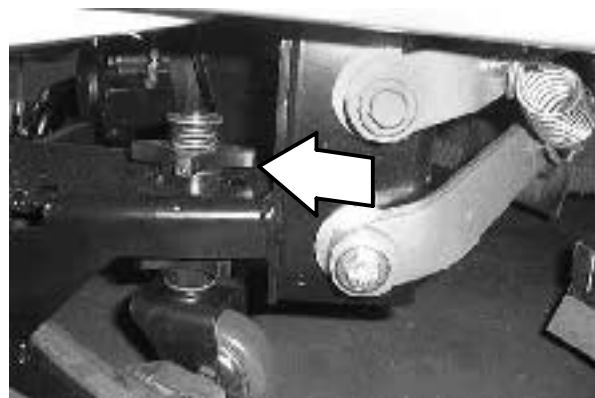

MAINTENANCE

SIDE SQUEEGEES

ADJUSTING THE SIDE SQUEEGEES

The side squeegee has one adjustment; height. To change the height adjustment, disconnect the squeegee spring from the clevis pin and move the clevis pin to a different hole location.

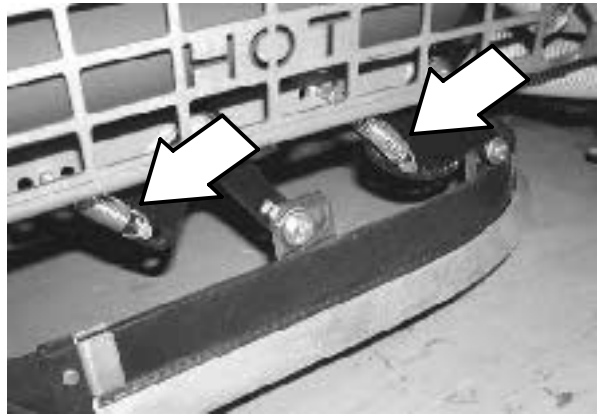

SQUEEGEE BLADES

REAR SQUEEGEE

The rear squeegee has two squeegee blades. Each blade has four wiping edges. To use them all, start with one wiping edge. To use the next wiping edge, rotate the blade end-for-end. To use the next wiping edge, rotate the top edges down, bottom edges up. To use the last edge, rotate the blade end-for-end.

Replace any worn or damaged squeegee blades.

REPLACING OR ROTATING REAR SQUEEGEE BLADES

1. Make sure the squeegee is raised off the floor.
2. Shut the engine off and set the parking brake.

FOR SAFETY: Before leaving or servicing machine; stop on level surface, set parking brake, turn off machine and remove key.

3. Open the retaining band clamp and remove the squeegee blade.
4. Replace or rotate the squeegee blade to allow a new edge to face the front of the machine.
5. Place the squeegee blade over the protrusions of the squeegee frame.



6. Position the retaining band over the squeegee blade. Latch the retaining band clamp.
7. Adjust the squeegee blade leveling and deflection as stated in *LEVELING THE REAR SQUEEGEE* and *ADJUSTING REAR SQUEEGEE BLADE DEFLECTION*.

SIDE SQUEEGEES

The side squeegees control water spray and channel water into the path of the rear squeegee. Check the side squeegees for damage and wear daily. Replace the side squeegee blades whenever they become damaged or lose their shape or resilience. Replace the squeegee deflectors whenever they become worn.

REPLACING SIDE SQUEEGEE BLADES

1. Raise the scrub head.
2. Turn off the machine and set the machine parking brake.

FOR SAFETY: Before leaving or servicing machine; stop on level surface, set parking brake, turn off machine and remove key.

3. Remove the cotter pin, clevis pin, deflector, and the retainer bracket from the front of the side squeegee.
4. Pull the squeegee blade off the front of the squeegee frame.
5. Slide the new squeegee blade onto the frame.

NOTE: Lubricating the squeegee frame where the squeegee makes contact will make for easier squeegee installation.

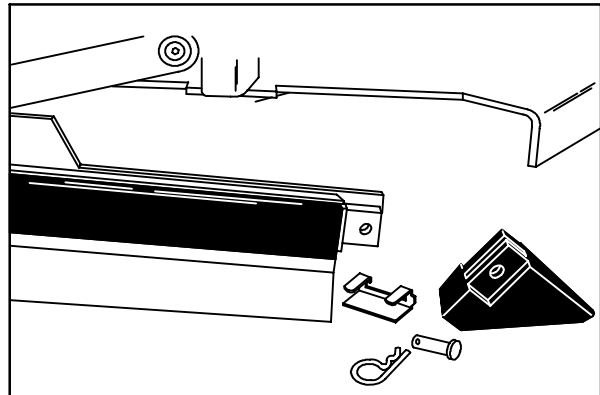

05942

6. Replace the retainer bracket, deflector, clevis pin, and cotter pin.
7. Repeat for the side squeegee on the other side of the scrub head.

SKIRTS AND SEALS

REAR SKIRTS

The two rear skirts are located on the bottom rear of the main brush compartment. The vertical skirt (rear) should clear the floor up to 3 mm (0.12 in) in dusty conditions, and touch the floor otherwise.

Check the skirts for wear or damage and adjustment daily.

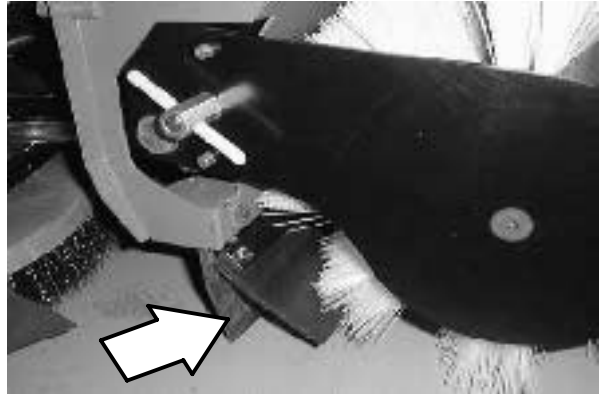

BRUSH DOOR SEALS

The brush door seals are located on the main brush door and on corresponding portions of the main frame.

Check the seals for wear or damage every 100 hours of operation.

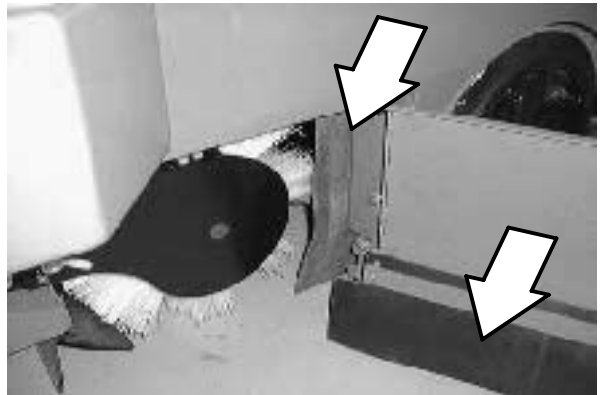

HOPPER LIP SKIRTS

The hopper lip skirts are located on the bottom rear of the hopper. The skirts float over debris and help deflect that debris into the hopper. The hopper lip skirts consist of five bottom lip segments and two additional side lip segments.

Check the hopper lip skirts for wear or damage daily.

Replace the hopper lip skirts when they no longer touch the floor.

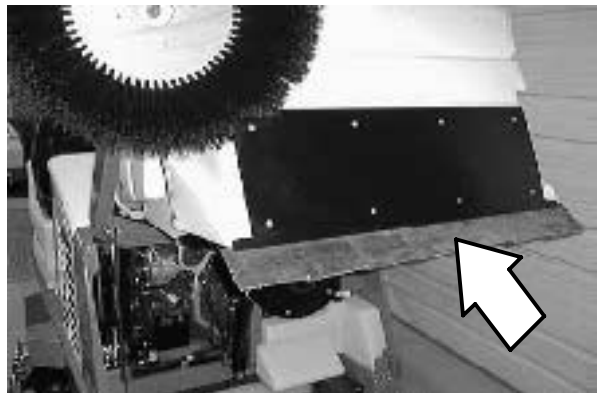

HOPPER SEALS

The hopper seals are located on the top and side portions of the machine frame that contact the hopper.

Check the seals for wear or damage every 100 hours of operation.

 **WARNING: Raised hopper may fall. Engage hopper support bar.**

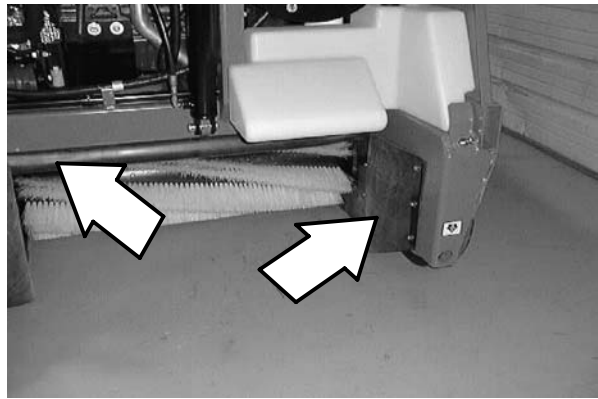
**HOPPER DOOR SEALS**

There are hopper door seals located on three sides of the hopper door. They seal the hopper when the hopper door is closed.

Check the seals for wear or damage every 100 hours of operation.

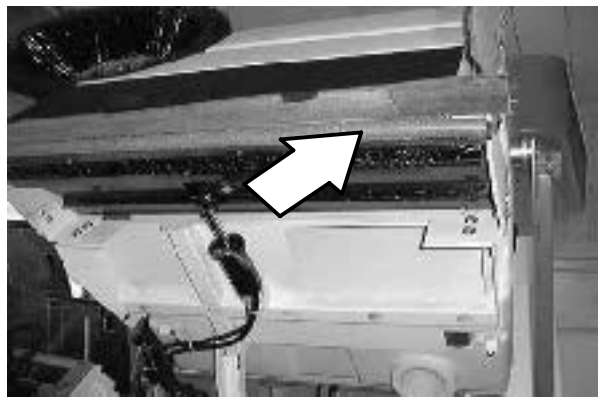
**HOPPER FILTER SEALS**

The filter seals are located on both sides of the dust filter. They seal the hopper filter to the cover and hopper.

Check the seal for wear or damage every 100 hours of operation.



MAINTENANCE

HOPPER VACUUM FAN SEAL

The hopper vacuum fan seal is mounted on the inside of the hopper around the vacuum fan inlet.

Check the seal for wear or damage every 100 hours of operation.

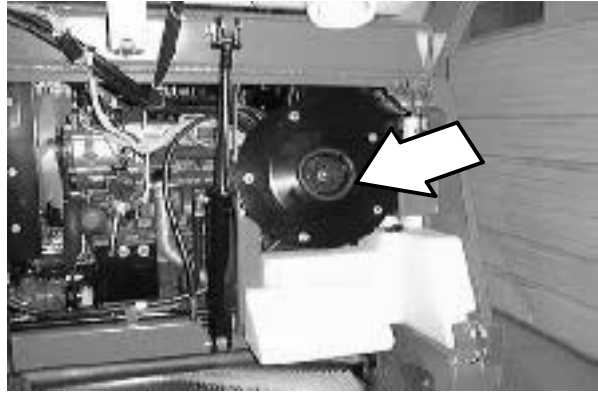

TANK COVER SEALS

Seals are located on the inside of the recovery tank cover and the solution tank cover.

Check the seals for wear or damage every 100 hours of operation.



BRAKES AND TIRES

SERVICE BRAKES

The mechanical service brakes are located on the front wheels. The brakes are operated by the foot brake pedal and connecting cables.

Check the brake adjustment every 200 hours of operation.

PARKING BRAKE

The parking brake is set with a parking brake pedal that locks the brake pedal.

TIRES

The machine tires are solid. Check the tires every 100 hours of operation for damage and wear.

REAR WHEEL

Torque the rear wheel nuts twice in the pattern shown to 142 to 156 Nm (105 to 115 ft lb) after the first 50-hours of operation, and every 800 hours there after.

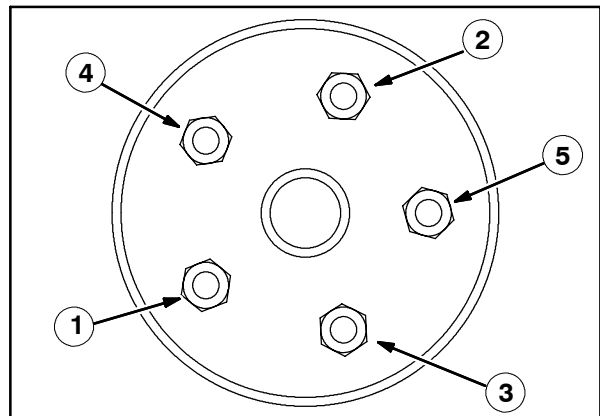

PUSHING, TOWING, AND TRANSPORTING THE MACHINE

PUSHING OR TOWING THE MACHINE

If the machine becomes disabled, it can be pushed from the front or rear, but towed only from the rear.

The propelling pump has a bypass valve to prevent damage to the hydraulic system when the machine is being pushed or towed. This valve allows a disabled machine to be moved for a *very short distance* and at a speed to not exceed 1.6 kp/h (1 mph). The machine is NOT intended to be pushed or towed a long distance or at a high speed.

ATTENTION! Do not push or tow machine for a long distance and without using the bypass valve, or the machine hydraulic system may be damaged.

Turn the bypass valve 90° from the normal position before pushing or towing the machine. **The illustration shows the bypass valve in the pushing or towing position.**

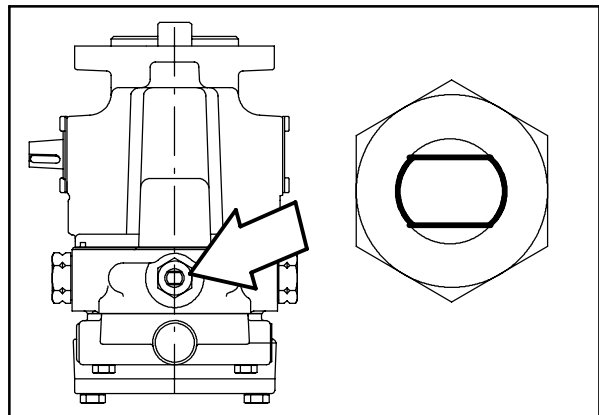
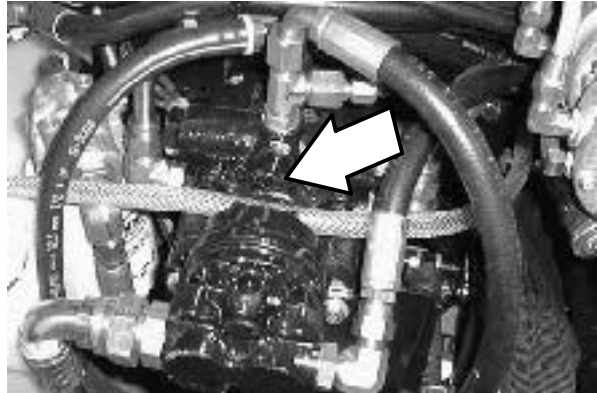

TRANSPORTING THE MACHINE

1. Position the rear of the machine at the loading edge of the truck or trailer.

FOR SAFETY: Use truck or trailer that will support the weight of the machine.

NOTE: Empty the hopper, recovery tank, and solution tank before transporting the machine.

2. If the loading surface is not horizontal or is higher than 380 mm (15 in) from the ground, use a winch to load machine.

If the loading surface is horizontal AND is 380 mm (15 in) or less from the ground, the machine may be driven onto the truck or trailer.

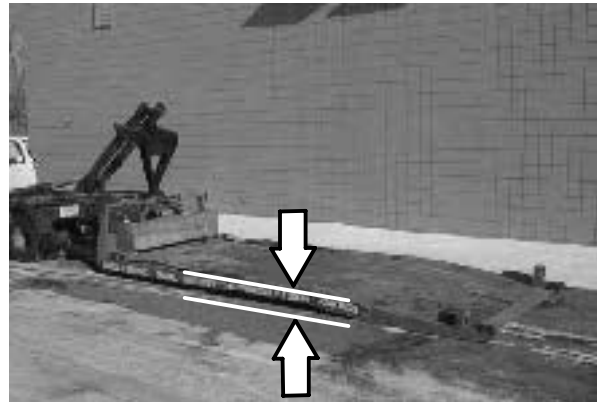

3. To winch the machine onto the truck or trailer, attach the winching chains to the rear tie down locations. The rear tie-down locations are the bottom lips at each corner of the rear bumper.



4. Turn the bypass valve 90° from the normal position before winching the machine onto the truck or trailer. See *PUSHING OR TOWING THE MACHINE* section of this manual. Make sure the machine is centered.

FOR SAFETY: When loading machine onto truck or trailer, use winch. Do not drive the machine onto the truck or trailer unless the loading surface is horizontal AND is 380 mm (15 in) or less from the ground.

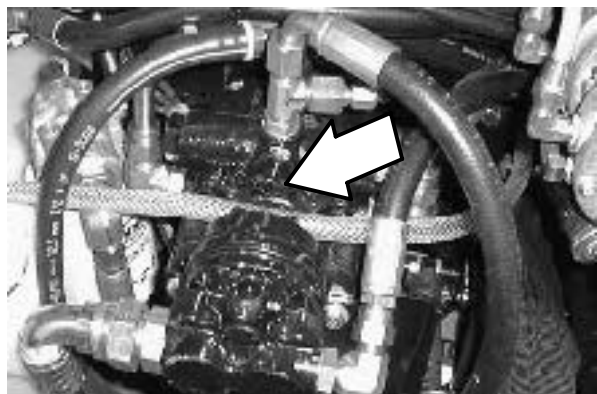

5. Position the machine onto the truck or trailer as far as possible. If the machine starts to veer off the centerline of the truck or trailer, stop and turn the steering wheel to center the machine.

MAINTENANCE

6. Set the parking brake, lower the scrub head and block the machine tires. Tie down the machine to the truck or trailer before transporting.

The front tie-down locations are the holes in the wheel pockets at the front of the machine frame.

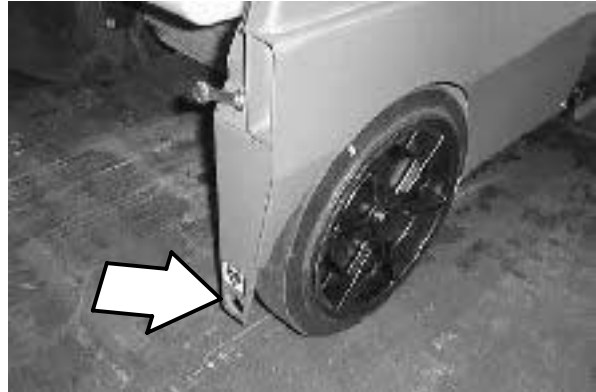

The rear tie-down locations are the bottom lips at each corner of the rear bumper.



7. If the loading surface is not horizontal or is higher than 380 mm (15 in) from the ground, use a winch to unload machine.

If the loading surface is horizontal AND is 380 mm (15 in) or less from the ground, the machine may be driven off the truck or trailer.

FOR SAFETY: When unloading machine off truck or trailer, use winch. Do not drive the machine off the truck or trailer unless the loading surface is horizontal AND 380 mm (15 in) or less from the ground.

MACHINE JACKING

Empty the hopper, recovery tank, and solution tank before jacking the machine. You can jack up the machine for service at the designated locations. Use a hoist or jack that will support the weight of the machine. Always stop the machine on a flat, level surface and block the tires before jacking the machine up.

FOR SAFETY: Before leaving or servicing machine; stop on level surface, set parking brake, turn off machine and remove key.

The front jacking locations are on the flat bottom edge of the front of the machine frame next to the front tires.



The rear jacking location is under the left side of the rear bumper.

FOR SAFETY: When servicing machine, jack machine up at designated locations only. Block machine up with jack stands.



STORING MACHINE

Before storing the machine for an extended time, the machine needs to be prepped to lessen the chance of rust, sludge, and other undesirable deposits from forming. Contact Tennant service personnel.

SPECIFICATIONS

SPECIFICATIONS

GENERAL MACHINE DIMENSIONS/CAPACITIES

Item	Dimension/capacity
Length	2550 mm (100.5 in)
Width with side brush	1395 mm (55 in)
Width with Maxpath side brush	1475 mm (58 in)
Height	1475 mm (58 in)
Height with overhead guard	2080 mm (82 in)
Track	1083 mm (42.6 in)
Wheelbase	1511 mm (59.5 in)
Main sweeping brush diameter	355 mm (14 in)
Main sweeping brush length	915 mm (36 in)
Scrub brush diameter - 2 brushes	510 mm x 2 brushes (20 in x 2 brushes)
Scrub brush diameter - 3 brushes (option)	410 mm x 3 brushes (16 in x 3 brushes) (option)
Side brush diameter	585 mm (23 in)
Sweeping path width	915 mm (36 in)
Sweeping path width with side brush	1270 mm (50 in)
Squeegee width	1219 mm (48 in)
Scrubbing path width - two scrub brushes	1015 mm (40 in)
Scrubbing path width - three scrub brushes (option)	1220 mm (48 in)
Main sweeping brush pattern width	64 mm (2.5 in) - adjustable
Hopper weight capacity	160 kg (350 lb)
Hopper volume capacity	220 L (7.8 ft ³)
Dust filter area	6 m ² (63 sq ft)
Solution tank	197 L (52 gal)
Recovery tank	265 L (70 gal)
Detergent tank	17.8 L (4.7 gal)
Total capacity with ES (option)	300 L (80 gal)
GVWR	1935 kg (4270 lb)
Ceiling height minimum dumping clearance	2286 mm (90 in)

GENERAL MACHINE PERFORMANCE

Item	Measure
Maximum forward speed	10.0 kmh (6 mph)
Maximum reverse speed	4.8 kmh (3 mph)
Minimum aisle turn width, left	3.01 m (9 ft 9 in)
Minimum aisle turn width, right	4.3 m (14 ft 10 in)
Minimum turning radius, left	0.98 m (38.75 in)
Minimum turning radius, right	1.91 m (75.25 in)
Maximum rated incline for transport of machine	(8° - 14%)
Maximum rated incline for scrubbing/sweeping	(6° - 10.5%)

POWER TYPE

Engine	Type	Ignition	Cycle	Aspiration	Cylinders	Bore	Stroke
Kubota V1505B-61	Piston	Diesel	4	Natural	4	78 mm	78.4 mm
	Displacement		Net power, governed			Net power, maximum	
	1498 cc (91.44 cid)		20.0 kw @ 2400 rpm (26.8 hp)			27.9 kw@ 2800 rpm (37.5 hp)	
	Fuel		Cooling system			Electrical system	
	Diesel Fuel tank: 37.9 L(10 gal)		Water/ethylene glycol antifreeze			12 V nominal	
			Total: 16.7 L (4.4 gal)			50 A alternator	
			Radiator: 6 L (1.6 gal)				
	Idle speed, no load		(Fast) governed speed, under load			Engine lubricating oil without filter	
1400 ± 25 rpm		2400 ± 25 rpm			6.15 L (6.5 qt) diesel rating <i>above</i> CD grade only		

STEERING

Type	Power source	Emergency steering
Rear wheel, hydraulic cylinder and rotary valve controlled	Hydraulic accessory pump	Manual

HYDRAULIC SYSTEM

System	Capacity	Fluid Type
Hydraulic reservoir capacity	25.4 L (6.7 gal) Fill to FULL line only	TENNANT part no. 65869 - above 7° C (45° F) TENNANT part no. 65870 - below 7° C (45° F)
Hydraulic total (all components, plumbing)	28.4 L (7.5 gal)	

BRAKING SYSTEM

Type	Operation
Service brakes	Mechanical drum brakes (2), one per front wheel, linkage actuated
Parking brake	Utilize service brakes, linkage actuated

TIRES

Location	Type	Size	Pressure
Front (2)	Solid	405 x 90 x 308 mm (16x3.5 x12.125 in)	-
Rear (1)	Solid	405 x 150 mm (16 x 6 in)	-

SPECIFICATIONS

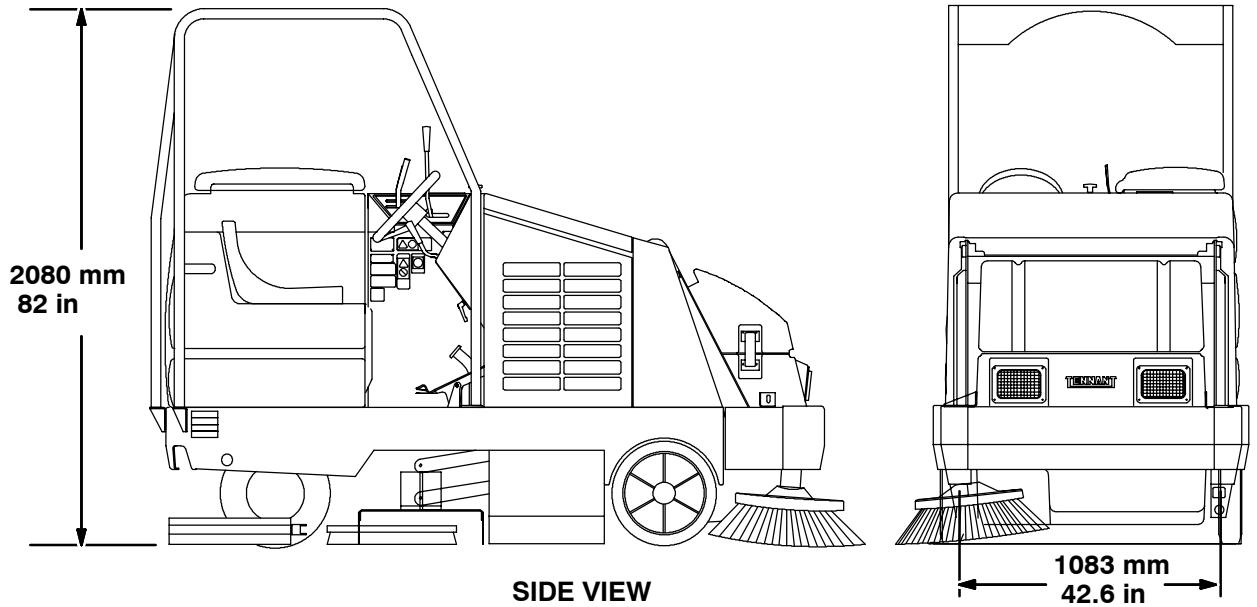
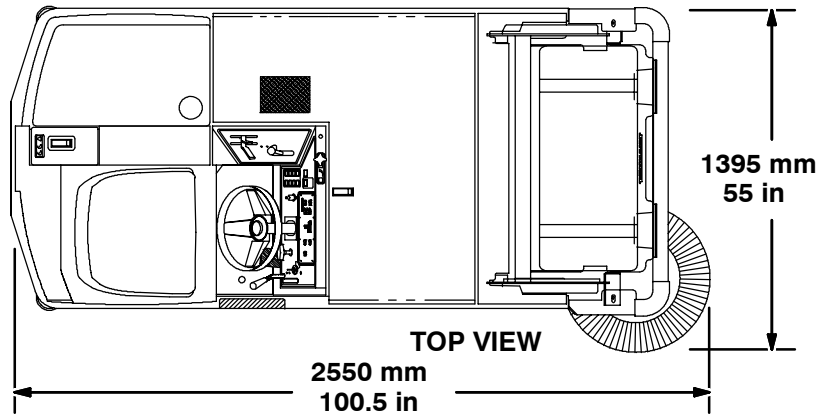

MACHINE DIMENSIONS

351664

INDEX

A

Adjusting blade deflection, 83–85
 Adjusting the side squeegees, 84–86
 Air filter, 66
 element, 66
 indicator (option), 65

B

Battery, 67
 Bearings, front wheel, 61
 Belts
 accessory pump, 68
 engine, 68
 Brake pedal, 13
 Brakes, 33, 51, 89
 parking, 89
 service, 89
 system specifications, 95
 Brush pressure adjustment, scrubbing, 18
 Brushes
 main sweep brush, 72–76
 main, taper adjustment, 76–80
 Maintenance, 33, 51
 Pattern adjustment, 33, 51
 scrub brush replacement, 80–82
 scrub brushes, 79–81
 side brush replacement, 78–82
 side sweep brush, 77–81
 sweep pattern adjustment, 75–79
 sweep, replacement, 73–77
 Bypass valve, 90

C

Capacities, hopper & tanks, 94
 Chain, static drag, 69
 Charging system light, 25
 Circuit breakers, 28
 Clogged filter light (option), 26
 Control panel
 detergent pump switch (option), 21
 edge scrub switch (option), 19
 engine speed switch, 21
 ES (option), 20
 filter shaker switch, 22
 fuel level gauge, 17

functions, 17
 hourmeter, 17
 operating lights switch, 23
 operating/hazard lights switch, 23
 recovery tank full indicator, 20
 scrub brush switch, 18
 solution flow switch, 23
 squeegee switch, 19
 sweeping vacuum fan switch, 22

Controls

brake pedal, 13
 directional pedal, 12
 hopper door lever, 17
 hopper lever, 16
 horn button, 27
 ignition switch, 14
 main sweep brush pressure knob, 15
 parking brake pedal, 13
 side sweep brush lever, 16
 side sweep brush pressure handle, 16
 steering column tilt lever (option), 14
 steering wheel, 14

Controls & instruments, 11

Cooling system, engine, 65

D

Detergent pump switch (option), 21
 Dimensions, overall machine, 94
 Directional pedal, 12

E

Edge scrub switch (option), 19
 Electrical system
 battery, 67
 circuit breakers, 28
 fuse, 28
 Engine
 accessory pump belt, 68
 Air filter, 33, 51
 air filter, 66
 air filter indicator (option), 65
 belt, 68
 Coolant level, 33, 51
 cooling system, 65
 fuel filter, 67
 Fuel level, 33, 51
 lubrication, 60
 oil capacity, 60
 Oil level, 33, 51
 specifications, 95

Engine cover gas spring, 31
Engine oil pressure light, 25
Engine speed switch, 21
Engine water temp light, 25
ES
 Clean tanks, 33, 51
 Detergent level, 33, 51
ES filter, 80
ES switch (option), 20

F

Filter, Vacuum fan inlet, 33, 51
Filter shaker switch, 22
Filters
 cleaning, hopper, 70–71
 ES (Extended Scrub), 80
 hopper, dust, 70–71
 removing, hopper, 71–72
Fuel filter, 67
Fuel level gauge, 17
Fuse, 28

G

Grease fittings, rear wheel support, 60

H

Handle, side sweep brush pressure, 16
Hopper
 disengaging hopper support bar, 54–56
 dust filter, 70–71
 dust filter cleaning, 70–71
 dust filter removal, 71–72
 engaging hopper support bar, 52–54
 lift arm pivots, 61
 support bar, 31
 Thermo Sentry, 71
Hopper door closed light (option), 27
Hopper door lever, 17
Hopper lever, 16
Hopper temp light - Thermo Sentry, 26
Horn button, 27
Hourmeter, 17
Hydraulic cooler, Fins, 33, 51
Hydraulic filter bypass light (option), 27

Hydraulics
 fluid, 63–65
 fluid filter, 62
 Fluid level, 33, 51
 fluid level, 62
 hoses, 64
 propelling motor, 64
 reservoir, 62
 system specifications, 95

I

Ignition switch, 14
Indicators
 charging system light, 25
 clogged filter light (option), 26
 engine oil pressure light, 25
 engine water temp light, 25
 hopper door closed light (option), 27
 hopper temp light - Thermo Sentry, 26
 hydraulic filter bypass light (option), 27
 OK light, 26
 recovery tank full, 20
Information
 about brushes, 36–38
 about scrub head, 72
 about scrubbing, 36–38
 about sweeping, 36–38

J

Jack points, 93–95

K

Knob, main sweep brush pressure, 15

L

Latches, 31
Leveling rear squeegee, 82–84
Levers
 hopper, 16
 hopper door, 17
 side sweep brush, 16
 steering column tilt (option), 14
Lights
 charging system, 25
 clogged filter (option), 26
 engine oil pressure, 25
 engine water temperature, 25
 hopper door closed (option), 27
 hopper temperature - Thermo Sentry, 26
 hydraulic filter bypass (option), 27
 OK, 26

Lights switch
 operating, 23
 operating/hazard, 23

Lubrication
 engine, 60
 front wheel bearings, 61
 rear wheel support, 60
 scrub head drag link arms, 61

M

Machine capabilities
 aisle turn dimensions, 94
 operating incline rate, 94
 travelling speeds, 94

Machine components, 8

Machine dimensions, illustrations, 96

Machine jacking, 93–95

Machine storage, 93

Machine tie down location, 92

Machine transport, tie downs, 55

Machine troubleshooting, 56–58

Main sweep brush, 72–76
 pattern, checking & adjustment, 75–79
 replacement, 73–77
 taper adjustment, 76–80

Main sweep brush pressure knob, 15

Maintenance, intervals chart, 58–60

Motors, propelling, hydraulic, 64

O

OK light, 26

Operations
 control panel functions, 17
 disengaging hopper support bar, 54–56
 double-scrubbing, 46–48
 draining & cleaning tanks, 47–49
 emptying the hopper, 40–42
 engaging hopper support bar, 52–54
 filling the tanks, 42–44
 how the machine works, 32
 on inclines, 55
 post-operation checklist, 51–53
 pre-operation checklist, 33–35
 scrubbing, 44–46
 starting the machine, 34–36
 stop scrubbing, 46–48
 stop sweeping, 39–41
 stopping the machine, 50–52
 sweeping, 38–40
 sweeping, scrubbing & brush info, 36–38

Operator responsibility, 7–8

Operator seat, 29
 adjustable (option), 29
 suspension (option), 29

Options, steering column tilt lever, 14

P

Parking brake pedal, 13

Pedals
 brake, 13
 directional, 12
 parking brake, 13

Pushing machine, 90

Pushing or towing the machine, 90

Pushing, towing, and transporting machine, 90

R

Radiator, Fins, 33, 51

Rear squeegee, 81–83
 adjusting blade deflection, 83–85
 blades, 84–86
 blades, rotation & replacement, 84–86
 leveling, 82–84

Rear wheel, 89

Recovery tank, Drain and clean, 33, 51

Recovery tank, 80

Recovery tank full indicator, 20

S

Safety
 engine cover gas spring, 31
 hopper support bar, 31
 labels, 5–7
 precautions, 3–5

Scrub brush pressure adjustment, 18

Scrub brush switch, 18

Scrub brushes, 79–81
 replacement, 80–82

Scrub functions
 double-scrubbing, 46–48
 draining & cleaning tanks, 47–49
 filling the tanks, 42–44
 scrubbing, 44–46
 stop scrubbing, 46–48

Scrub head, 72

Scrub head drag link arms, 61

- Seals, 86–90
 - brush door, 86–90
 - hopper, 87–91
 - hopper door, 87–91
 - hopper filter, 87–91
 - hopper vacuum fan, 88–92
 - Tank Cover, 33, 51
 - tank covers, 88–92
 - Seat
 - adjustable (option), 29
 - operator, 29
 - suspension, (option), 29
 - Service records, 33, 51
 - Side Squeegees, 84–88
 - Side squeegees, 85–87
 - Adjusting the side squeegees, 84–86
 - blade replacement, 85–87
 - Side sweep brush, 77–81
 - replacement, 78–82
 - Side sweep brush lever, 16
 - Side sweep brush pressure handle, 16
 - Skirts, 86–88
 - hopper lip, 86
 - rear, 86
 - Skirts and seals, 33, 51
 - Solution flow switch, 23
 - Solution flow valve, manual, 24
 - Solution tank, 81
 - Specifications
 - braking system, 95
 - engine power type, 95
 - hydraulic system, 95
 - machine capacities, 94
 - machine dimensions, 94
 - machine performance, 94
 - machine weight, 94
 - steering, 95
 - tires, 95
 - Squeegee, Adjustment, 33, 51
 - Squeegee switch, 19
 - Squeegees, 81–83
 - leveling, 82–84
 - rear squeegee, 81–83
 - rear, blade deflection, 83–85
 - rear, blade rotation, 84–86
 - rear, blades, 84–86
 - side, 85–87
 - Side Squeegees, 84
 - side, blade replacement, 85–87
 - Static drag chain, 69
 - Steering, 33, 51
 - specifications, 95
 - Steering column tilt lever (option), 14
 - Steering wheel, 14
 - Storing machine, 93
 - Sweep brush, main, 72–76
 - pattern, checking & adjustment, 75–79
 - replacement, 73–77
 - taper adjustment, 76–80
 - Sweep brush, side, 77–81
 - replacement, 78–82
 - Sweep functions
 - emptying the hopper, 40–42
 - stop sweeping, 39–41
 - sweeping, 38–40
 - Switch
 - detergent pump (option), 21
 - engine speed, 21
 - filter shaker, 22
 - operating lights, 23
 - operating/hazard lights, 23
 - solution flow, 23
 - vacuum fan, sweeping, 22
 - Switches
 - edge scrub (option), 19
 - ES (option), 20
 - ignition, 14
 - scrub brush, 18
 - squeegee, 19
 - Symbol definitions, 9–11
- T**
- Tanks
 - recovery tank, 80
 - solution, 81
 - Thermo Sentry, 71
 - Tie down location, 92
 - Tie downs, 55
 - Tires, 89
 - rear wheel torque nuts, 89
 - specifications, 95
 - Towing machine, 90
 - Transporting machine, 90
 - Transporting the machine, 91
 - Troubleshooting, 56–58
- V**
- Vacuum fan switch, sweeping, 22
 - Valve, solution flow, 24